

Large Volume, High-Performance Applications of Fibers in Civil Engineering

VICTOR C. LI

ACE-MRL, Department of Civil and Environmental Engineering, University of Michigan, Ann Arbor, Michigan 48109

Received 8 November 2000; accepted 18 November 2000

ABSTRACT: This article presents an overview of fiber applications in cementitious composites. The socio-economic considerations surrounding materials development in civil engineering in general, and fiber reinforced cementitious materials in particular, are described. Current FRC applications are summarized, and the where, how, and why fibers are used in these applications, are documented. An attempt is made to extract common denominators among the widely varied applications. The R&D and industrial trends of applying fibers in enhancing structural performance are depicted. An actual case study involving a tunnel lining constructed in Japan is given to illustrate how a newly proposed structural design guideline takes into account the load carrying contribution of fibers. Composite properties related to structural performance are described for a number of FRCs targeted for use in load carrying structural members. Structural applications of FRCs are currently under rapid development. In coming years, it is envisioned that the ultra-high performance FRC, with ductility matching that of metals, will be commercially exploited in various applications. Highlights of such a material are presented in this article. Finally, conclusions on market trends are drawn, and favorable fiber characteristics for structural applications are provided. © 2002 John Wiley & Sons, Inc. *J Appl Polym Sci* 83: 660–686, 2002

Key words: FRC; ECC; fiber; composites; structure

INTRODUCTION

The use of fibers to reinforce a brittle material can be traced back to Egyptian times when straws or horsehair were added to mud bricks. Straw mats serving as reinforcements were also found in early Chinese and Japanese housing construction. The modern development of steel fiber reinforced concrete may have begun around the early 1960s, preceded by a number of patents.¹ Polymeric fibers came into commercial use in the late 1970s, glass fibers experienced widespread use in the 1980s, and carbon fiber attracted much attention in the early 1990s.

Fibers are generally used in one of two forms—short staple randomly dispersed in the cementitious matrix of a bulk structure, or continuous mesh used in thin sheets. In recent years, some attempts to weave synthetic fibers into three-dimensional reinforcements have been made. In addition, fiber-reinforced plastic rods are currently entering the market as replacement of steel bar reinforcements. Beyond cementitious matrix, fiber-reinforced plastics are finding increasing use in the civil engineering industry. However, this article will focus only on the material with the currently largest consumption of fiber—randomly oriented fiber-reinforced cementitious matrix (cement, mortar, and concrete) materials (hereafter abbreviated as FRCs). Based on industrial sources, the amount of fibers used worldwide at present is estimated at 300,000 tons per year, and

Contract grant sponsor: National Science Foundation.

Journal of Applied Polymer Science, Vol. 83, 660–686 (2002)
© 2002 John Wiley & Sons, Inc.

is projected to increase. In North America, the growth rate has been placed at 20% per year. However, it should be pointed out that FRC remains a small fraction of the amount of concrete used each year in the construction industry.

Fibers may have been originally introduced in an attempt to "strengthen" the matrix, without consciously distinguishing the difference between material strength and material toughness. As the study of FRC evolved into a scientific discipline, it became generally recognized that the most significant effect of fiber addition to the brittle cementitious matrix is the enhancement of toughness. For most FRCs, this means the capability of the material to carry tensile load, albeit at a decreasing level with opening of a crack after its formation. For certain FRC with continuous and/or high-fiber volume fractions, the ability of fibers in substantially increasing the tensile ductility has been recognized since the work of Aveston et al.² However, it is only in recent years that such ductility accompanied by strain-hardening can be derived by a moderately low amount of randomly oriented discontinuous fibers (e.g., less than two volume percent) by carefully tailoring the matrix, interface, and fiber via the help of micromechanics. As a result, a new class of economically viable, field processable, high-performance damage-tolerant material is emerging. Emphasis on composite tailoring also brings with it the need to control fiber characteristics to meet the performance need and economic constraints in construction applications of this new type of FRC.

In the next section, broad socioeconomic considerations surrounding materials development in civil engineering in general, and fiber reinforced cementitious materials in particular, are described. The section entitled Current Applications of FRCs summarizes current FRC applications worldwide, and documents where, how, and why fibers are used in these applications. An attempt is made to extract common denominators among the widely varied applications. Most current use of FRCs is in nonstructural or, at most, semistructural applications. The following section describes the research and development and industrial trends of applying fibers in enhancing structural performance. An actual case study involving a tunnel lining constructed in Japan is given to illustrate how a newly proposed structural design guideline takes into account the load-carrying contribution of fibers. Composite properties related to structural performance are described for a number of FRCs targeted for use in load-carrying structural members. Structural ap-

plications of FRCs are currently under rapid development. In coming years, it is envisioned that the ultrahigh-performance FRC, with ductility matching that of metals, will be commercially exploited in various applications. Highlights of such a material are described in the section entitled Strain-Hardening Cementitious Composites. In the final section, conclusions on market trends are drawn, and favorable fiber characteristics for structural applications are provided. Emphasis is placed on the need for fiber and surface characteristics most suitable for the ensuing applications and performance needs of future FRCs.

SOCIOECONOMIC CONSIDERATIONS

Civil infrastructures are organic, in the sense that they grow with the years. The Akashi-Kaikyo Bridge in Kyoto, Japan, recently completed in April 1998, has the longest suspended span (1990 m) of all bridges in the world. At 450 m, the Petronas Twin Tower in Malaysia (completed in 1996) is the tallest building in the world. No doubt these records will be shattered in the near future. Behind this growth is the development of advanced construction materials.

Unfortunately, when put in perspective, civil and building engineering materials development does not have a good track record, in comparison with other industries. Part of the reason comes from the lack of cooperation/coordination between the construction industry and the construction material supplying industry. Especially in the United States, joint research and development between materials suppliers and the construction industry is relatively nonexistent. Such fragmentation between materials development and infrastructures is not conducive to the healthy growth and maintenance of our societies' infrastructures. The negative impact of this stance on construction productivity, durability, and public safety cannot be underestimated.

The magnitude of our infrastructure need is enormous. Put in economic terms, about 10% of gross domestic product derives from infrastructure construction worldwide. In the United States alone, infrastructure construction is a \$400 billion industry involving 6 million jobs. We have approximately \$17 trillion worth of infrastructures in place. Advanced construction materials must contribute to the organic growth of our new infrastructures, and at the same time, contribute to maintaining the health of our infrastructure inventory. The implications of advanced civil en-

gineering materials in the world economy are significant.

There are a number of unique characteristics of civil/building engineering materials which set them apart from those used in other industries. These characteristics include:

- Low cost—for example, concrete costs \$0.1/kg (in contrast to eye contact lens which cost \$100,000/kg).
- Large volume application—e.g., on a world-wide basis, 6 billion tons of concrete and a half billion tons of steel are used in infrastructure construction annually.
- Durability requirement—our infrastructures generally are designed for much longer life than consumer goods, e.g., most bridges are designed with a 75-year service life, compared with an automobile with a typical design life of 10–20 years.
- Public Safety—it goes without saying that the general public will not tolerate failure of infrastructures. The experiences from the recent Northridge earthquake in the United States and the Kobe earthquake in Japan serve important lessons.
- Construction labor—materials have to be processed into infrastructures. Construction workers generally do not have the same kind of training ceramics engineers have. This implies that the material, if processed at a construction site, must be tolerant of low-precision processing.

The above unique characteristics need to be observed when developing advanced construction materials. They may be regarded as overall constraints. Only materials meeting such constraints will be successfully adopted in the real world. For FRC, the first two constraints on cost and applications in large-scale structures imply that fibers cannot be overly expensive and must be used in relatively small volume content.

Viewed in a more positive light, some of the above constraints also make materials serve as enabling technology for infrastructures. Proper selection of fiber and matrix materials is critical in producing durable infrastructures. FRCs with high ductility lead to safer infrastructures. Materials can even lend themselves to improving construction productivity. For example, the replacement of re-bars in reinforced concrete (R/C) structures with FRCs have led to reduction in labor cost in construction sites. Finally, because of the

large amount of materials used in construction, the negative impact (through energy consumption and pollution) on our environment can be significant. However, we can enable sustainable infrastructures to be developed by using more recycled materials (e.g., fly ash, silica fumes, and waste fibers (or seconds)) in infrastructure with enhanced durability.

In summary, construction materials can, and should, play an important role in our infrastructure development and renewal. The obvious impact on society in economics, public safety, and the environment must be recognized.

CURRENT APPLICATIONS OF FRCs

Most current applications of fibers are nonstructural. Fibers are often used in controlling (plastic and drying) shrinkage cracks, a role classically played by steel reinforcing bars or steel wire-mesh. Examples include floors and slabs, large concrete containers, and concrete pavements. In general, these structures and products have extensive exposed surface areas and movement constraints, resulting in high cracking potential. For such applications, fibers have a number of advantages over conventional steel reinforcements. These include: (a) uniform reinforcement distribution with respect to location and orientation, (b) corrosion resistance especially for synthetic, carbon, or amorphous metal fibers, and (c) labor-saving by avoiding the need of deforming the reinforcing bars and tying them in the form-work, which often leads to reduction of construction time. Elimination of reinforcing bars also relaxes constraints on concrete element shape. This functional value of fibers has been exploited in the curtain walls of tall buildings. The Kajima Corporation (Japan) has taken advantage of fibers in the manufacture of curvilinear-shaped wall panels valued for their aesthetics (see, e.g., Fig. 1). In some applications, the use of fibers enables the elimination or the reduction in the number of cut-joints in large continuous structures such as containers (Fig. 2) and pavements. Especially in pavements, joints are locations of weaknesses at which failure frequently occurs. Thus, fibers have been exploited to enhance the durability of concrete elements. Some additional representative industrial applications of FRCs are shown in Figures 3–5. These examples are chosen to illustrate the wide range of fiber used (steel, glass, polymer, amorphous metal, carbon) and the international nature of FRC applications.

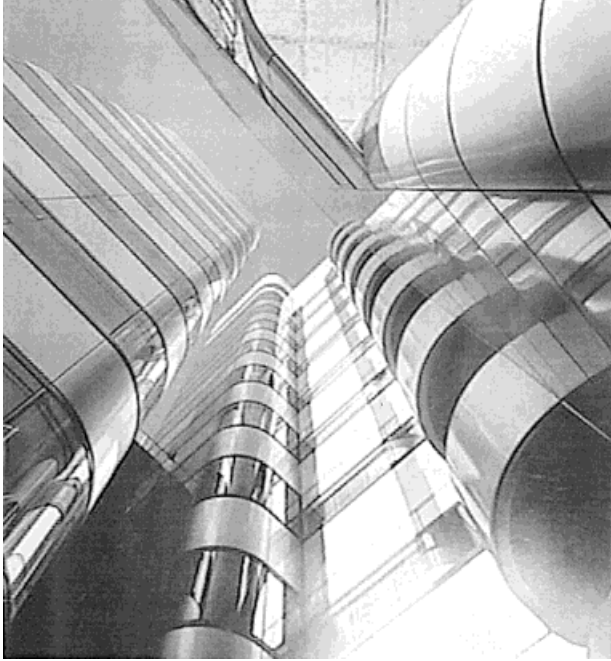

Figure 1 Japanese curvilinear carbon-FRC curtain walls.

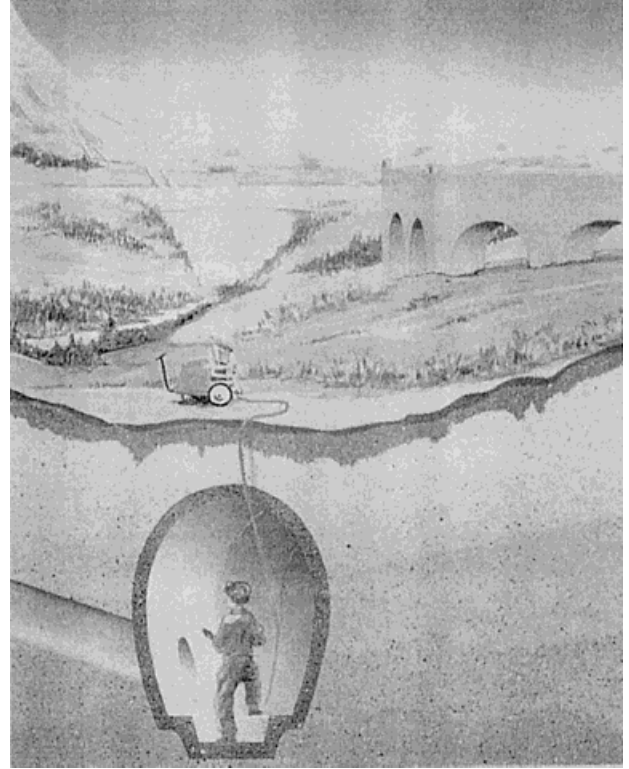

Figure 3 French Metglas FRC underground tunnel linings.



Figure 2 Danish pp-FRC containers.

Durability is an important performance-enhancement characteristic in many industrial FRC applications. Naturally, durability has different connotations in different application contexts. For example, for containers, durability implies the lifetime prior to unacceptable leakage. For pave-



Figure 4 U.S. glass-FRC wall panels.



Figure 5 German steel–FRC airfield pavement.

ments, durability implies the repair time interval in order to maintain rideability. The cause of loss of durability is also very much dependent on the specific application and field conditions.

Repair of concrete structures appears to be a sizable application of FRCs. This includes restoration of pavements, airfields, bridge decks, and floor slabs. With the decaying infrastructure coupled with increasing demand in their performance in most industrialized countries, it is expected that the need for durable repairs will increase over time. Fundamental understanding of durable repairs is lacking at present. However, it is generally agreed that repair failures are often related to mechanical property incompatibility between the repair material and substrate concrete. Dimensional stability of the repair material and delamination resistance are often cited as some of the controlling factors. Fibers can be, and have been, used to advantage in this area.

The adoption of new materials in the highly cost-sensitive construction, building, and precast products industries (grouped together as the “construction industry” hereafter) generally requires justification of cost advantage. The dollar value of durability is difficult to quantify, but durability demand clearly represents one of the driving forces in the use of fibers, especially when shrinkage crack resistance is considered. As mentioned above, labor saving via elimination of joints or re-bars provides extra financial incentives. Other cost advantages in the use of fibers include element thickness and/or weight reduction, such as in concrete pipes, pavements, and building curtain wall panels. In the case of building curtain walls, weight reduction can lead to significant

savings in building foundation cost, hoisting machinery, steel reinforcement, and transportation cost. For example, the Kajima Corporation claims a reduction in external wall load of 60% and structural steel requirement of 4000 tons for the Tokyo Ark-Mori building which used 32,000 m² of CFRC (carbon fiber FRC) wall panels. Reduction in construction time is highly valued (e.g., in fiber shotcreting of tunnel linings common in Sweden and Austria) and represents major cost advantage in the construction industry.

There is no question that fibers lead to concrete element performance improvements in a wide range of applications, providing the benefit part of the cost/benefit ratio consideration. Apart from durability against shrinkage cracks, fibers are valued for their imparting the concrete element with energy absorption capability—often described in terms of their impact resistance (e.g. floors and slabs), and delamination and spall resistance (e.g., concrete structure repair). Other performance improvements include corrosion and fatigue resistance.

To achieve such performance enhancements, two essential properties of FRCs are utilized. As replacements for steel reinforcements and joints, fibers contribute to the shrinkage crack resistance property of the FRC. Impact resistance performance (and to a certain extent bending strength) is linked to the fracture toughness of the composite. Fibers are very effective in this respect, much more so than in increasing composite tensile strength or ductility (strain capacity) in current FRCs. [The exception to this “rule” is being realized in the laboratory; see Strain-Hardening Cementitious Composites below.] The shrinkage crack resistance and toughness property of FRCs are well recognized and exploited in current concrete element applications in the construction industry. Because of the utilization of improved mechanical properties of FRC, some industrial applications can be considered semi-structural. These properties are needed to carry dead loads, handling (or construction) loads, loads related to restrains from dimensional changes, etc. Wall panels and some pavement applications belong to this category. However, in most of these applications, the fibers are not expected to contribute to load-carrying function in the element.

Some examples of current industrial applications of FRCs are summarized in Table I.⁷ This table provides a broad overview of wide-ranging applications in different parts of the world. However, it is by no means exhaustive. Some of these applications are experimental, in the prototyping

stage of development. They are indicated with an asterisk. The properties utilized, application performance improvements, and cost advantage or justifications are also included for each application. In this table, the nature of how the FRC has been used is identified by the symbols N = non-structural, SS = semistructural, and S = structural. Many applications lie in the gray zone between nonstructural, semistructural, and structural applications. The classification is therefore somewhat subjective. Even so, it is clear that at the present time, straight structural applications of FRC are in the minority, but growing.

It is noted that most fibers currently in use are either steel or polypropylene fibers. These are relatively low-cost fibers and generally satisfy the composite property needs and the concrete element performance needs as described above. Glass fibers have been used extensively in wall panel type applications. However their real/perceived problems in durability appear to have slowed down their market expansion, at least for the near future. A number of litigation cases in the United States involving time-delayed cracking of wall panels with glass fibers have added to concerns by end-users. Other fibers used in large quantities include cellulose fiber, often used as processing aids rather than for their reinforcing capability. As is well known, asbestos fibers (often used in thin-sheet elements) are increasingly displaced, at least in the United States and in many countries in Europe, because of carcinogenic health hazard potential. Newcomers on the market for concrete reinforcements are Metglas® (amorphous metal), carbon, and certain high-performance polymer fibers. Metglas is produced in France and its applications appear mostly limited to France at the present time. Production of carbon and polyvinyl alcohol (PVA) fibers is currently led by Japanese manufacturers, although some production facilities of these fibers have in the last few years been started up in China. Each of these fibers has their limitations. For example, most carbon fibers are brittle (low bending strength or tensile strain capacity), and some studies have suggested durability problems in composites reinforced with certain PVA fibers. However, manufacturers of these fibers are continuously advancing the properties of these fibers so that some of these problems may be expected to be overcome in the future.

In most applications, fibers are used in less than 1% by volume. Fiber content in FRC is limited by cost (cost of fibers are much higher than Portland cement (~ \$0.03/lb.) and aggregates

(~ \$0.004/lb.), even for the lowest-cost fiber), and processability (measured in terms of workability for concrete mixing and casting). In special product lines, such as thin roofing tiles and other thin-sheet products, as well as in FRC protective shields and other products that can tolerate higher cost for additional performance needs, larger amounts of fibers have been used. Examples include SIFCON (slurry infiltrated concrete, invented in the United States and used in airfield pavements) and CRC (compact reinforced concrete, invented in Denmark and used in safety vaults). These FRCs have fiber content ranging from 5% to 20%. Special processing techniques are required. SIFCON requires bedding of fibers into a concrete form followed by infiltration of the fiber bed by a high w/c ratio mortar slurry. CRC requires high frequency vibration applied directly to a dense array of steel reinforcements to reach acceptable material compaction. For thin-sheet products, the Hatchek technique is common in processing the composite with high-content fibers which serve as the main reinforcement in such products.

One of the major drawbacks in many current FRC applications is that the development of the FRC is often decoupled from the design of the concrete element. Furthermore, the detailed effect of fiber addition to the composite property, and hence to the performance improvement of the concrete element is often not quantified. Instead, decisions on the choice of fibers and the fiber content chosen are often reflections of experience on the part of the user. Unfortunately, this often leads to results that fail to meet expectations. A good example is the use of steel fibers in pavements. Many successful uses of fibers in pavements have been reported,³ in some cases even with the pavement thickness reduced. However, just as many cases have shown disappointing results.⁴ There are a variety of reasons for this to happen. The loading condition (environmental or mechanical) can be different, e.g., for pavements located in different states. Because of this, there is a certain amount of luck factor involved in successful applications. A ramification of this result is that users become disenchanted over the use of fibers. The lack of systematic design guidelines and mixed experience in FRC applications to concrete elements are responsible for slowing the spread of FRCs to even broader industrial applications, despite their many advantages as described above.

Although the current application of fibers in concrete elements is limited in scope, it appears to

Table I FRC Industrial Applications

Applications	Fiber	V _f (%)	S?	Properties Utilized	Performance Improvements	Cost Reduction	Amount Appl. & Location	Reference
Pavement overlay* 35 m long, 10 cm thick	pp + steel	0.75 + 0.75	SS	Shrinkage crack res. Tensile strain cap.	Durability: no failure at joints	Thick. red. to ½ No steel reinf. No cut joint	Denmark	Glavind, '93; Ramboll Hannemann & Hojlund, '92
Pavement 75–175 mm thick	steel	0.5–1	SS	Shrinkage crack res. Flexural strength	Durability?	Greater joint spacing	Canada	Balaguru & Shah, '92
Pavement* "full depth" Thin bridgedeck overlay	pp monofils	1	SS	MOR, toughness	Impact resistance chemical resistance fatigue resistance	Compete with steel fibers	US	Van Mier, '95 Ramakrishnan, '93
Pavement 200 mm thick, 80 m long	pp	0.7	N	Shrinkage crack res.	Durability	No steel No shrinkage control joint	U.K.	Crackstop News, No. 1, '90
Pavement whitetopping 100 mm	steel	1	N	Wear resistance	Durability Stop rutting of asphalt Noise reduction	Less than complete replacement of flex. pavement	Canada	Johnston, '95
Repair Pavement	pp	1–1.5	N	Toughness Interface bond	Crack res. Delamination res.	Life-cost	Denmark	Glavind & Stang, '94
Repair Airfield pavement	SIFCON	5	SS	Toughness Interface bond	Crack & spall res. Delamination res.	Life-cost Simplicity in slip-form paving		Glavind & Stang, '94
	steel	0.75		Energy absorption MOR Tensile strain cap.	Impact res. (dyn. load from planes) Fatigue res.	Incr. in joint spacing		Balaguru and Shah, '92
Repair Airfield runway patch	steel	?	N	Elastic modulus COE	Compatibility with substrate concrete	Life-cost	Germany US	Harex fiber broc. Balaguru & Shah, '92
Repair Bridge substructure	steel	0.3	N	Toughness	Durability Fatigue res.	Reduced thickness	Canada	Johnston, '95
Repair General	pp pp + steel	0.2 1.7–2.5	SS	Toughness Interface bond	Impact res. Crack res. Delamination res.	Life-cost No shrink. reinf. Thick. red.	Denmark	Ramboll Hannemann & Hojlund, '92
Industrial floor restoration	Metglas	1	SS	Adhesion 3MPa, Compress. 80 MPa, MOR 12 MPa	Self-leveling, Chem. corr. res. Shock, abrasion, crack res.	Life-cost	France	St. Gobain, Lanko
Industrial floor rehabilitation Thin overlay	steel	0.5	SS	Ductility Toughness	Long term bond to existing base Spall res. Damage res. from forklift	Reduce production facility downtime Long term performance	US	Smith, R., '95
Rendering, floor screeding	pp	?	N	Shrinkage crack resist, crack stop	Durability	No need for sand →strength and bond	Denmark	D. Davis, Danaklon lit.
Floors & Slabs	pp steel	0.1 0.3–0.5	n	Shrinkage crack res. Toughness "+ energy absopt., MOR, toughness	Durability Impact res. (dyn. wheel load form fork lift); Easy processing, High reliability	Life-cost replaces mesh, reduce labor, slab thickness, incr. joint spacing, faster construction, lower maint. cost	300K m ² , Denmark	Glavind & Stang, '94 Bache, '92 Densitop Broc. Bekaert Broc.
	Metglas				Spall res. Fatigue res. Chemical res.			St. Gobain, Lanko
Parking garage floor 150 mm thick slabs 16 × 8 m	pp	0.9	N	Shrinkage crack res.	Durability	No steel mesh	Denmark	Crackstop News, No. 1, '90
Bridge deck slabs*	pp	0.88	SS	Shrinkage crack res. Shear resistance	Durability	Replace steel reinf., Caontrol corrosion	Canada	Mufti et al, '93
Curtain wall panels	carbon	2–4	SS	Low density Strength Shrinkage crack res.	Light-weight Seismic force red. Fire res. Dim. stability Durability	Build. weight red. Found. cost red. Steel red. Transp. cost red. Erec. cost red. Constr. time red. Shape flexibility	300K m ² Japan	CFRC Broc., Kajima
Wall panels	carbon	2	SS	MOR Low density	Avoid corner damage & cracking Durable against sunlight, heat and salt	Increase design flexibility Light-weight	Kitakyusu Prince Hotel 12 tons Japan	Mitsubishi Kasei Broc. Ando,
Lightweight cladding panels skin 40,75 mm thick	stainless steel	1.3	SS	MOR Low density	Durability, Res. wind load		Sail Clubhouse Australia	Fibresteel, Vol 4 No. 1, '92
Thin shells & facades	AR glass	4–5	SS	Shrinkage crack res. Tensile strength Toughness MOR	Durability Shape desg flex.	No steel reinf. Low weight per unit area, building deadload, foundation cost	65K m ² , Denmark	Glavind & Stang, '94

Table I Continued

Applications	Fiber	V _f (%)	S?	Properties Utilized	Performance Improvements	Cost Reduction	Amount Appl. & Location	Reference
Tunnel linings	steel	0.5-1	S	Strength, MOR Toughness Energy absorption Shrinkage crack res.	Safety Durability Better bonding to underlay Maintain contour Water tightness	Replace wire-reinf., No reinf. corrosion Constr. time & labor red. (with shotcreting) Thickness red. Constr. safety	80K m ³ /yr., Norway	Skerendale, '94 Horri & Nanakorn, '93; Maage, M., '94 Bekaert Broc. EE-fiber Broc. St. Gobain Broc.
Sewage network linings*	Metglas Metglas	>25 kg/m ³	SS	MOR Crack resistance	Corrosion resistance Durability	Replace wire-mesh, labor, Reduce thickness	Shotcrete, France	St. Gobain lit.
Drainage canal in tunnel	CRC steel	6	S	MOR	fatigue resistance durability (100 yrs) non-conducting (elec. sys. of train) chem. resistance	Thin cover	40K element 500x400x 40 mm ³ , Denmark	Van Mier et al., '95
Wear linings, hydraulic structures	steel		N	Abrasion rs.	Durability	Life-cost	Denmark	Glavind & Stang, '94
Underground railway system	pp	"sm. amt."	N	Shrinkage crack res.		Durability	Poland	Brandt et al, '94
Containers agriculture process sludge purifying	pp	2	SS	Shrinkage crack res. Elastic modulus	Durability Water-tightness	Mat'l cost 2x thickness red. No cut joint' No steel reinf.	25-30K m ³ , Denmark	Glavind & Stang, '94 Fiberbeton R&S, Denmark
Septic tanks	steel	?	SS	MOR	Bending load res.	Wall thick. red., Labor & mat'l red. Mass & weight red. Cost less than mesh Economical w/o wire-mesh reinforcement	Australia	Fibresteel, V.4 No. 1, '92
Pipe*	steel	0.3-0.5	SS	MOR Crack res. Ductility MOR	Bending load res. Spall res. Corrosion res. Bending load res.	Wall thick. red. to 1/3 of normal	Belgium	Dramix broc. and design doc.
Pipe*	steel	1.75	SS				Denmark	Thygesen, '93 Pedersen & Jorgen, '92
Anti-blast doors military shelters	Metglas	?	S	Ductility	Lightweight, Dynamic energy absorption	Replace steel, same weight, lower cost	France	St. Gobain lit., Dynabeton by Sogea
Security products	CRC steel	6	S	Strength Ductility Energy Absorp. Energy Absorp.	Impact Res.	High-cost	Denmark	Bache, '87
Vaults and safes	steel	1-3	S		Impact Res.	Thickness reduction (~2%)	U.S.	Balaguru & Shah, '92
Tetrapods (dolosse)	steel?	?	SS	Energy absorption	Impact res.		30K m ³ Australia	Engineer update, '84
Sea defense work concrete	pp	0.9	N	Plastic shrinkage crack res.	Durability against wind/exposure		4 tonnes, Denmark	Crackstop News, No. 1, '90
Refractories	Stainless steel	?	SS	Tensile MOR	Thermal shock resis. Spall resist. thermal shock resist.	Durability Reliability	Belgium	Bekaert Broc.
Refractories e.g. lip rings for iron ladles, furnace hearths	stainless steel	?	SS				U.S.	Lankard, '92
Columns (RPC in steel tube)	steel	2-4.5	S	Strength, Toughness	Seismic resistance	Slender columns	France	Richard & Cheyrezy, '94
Column/Slab cast-in-place joint	CRC steel	?	S	Toughness	Short development length for reinf.	Building system flexibility	Denmark	Van Mier et al, '95
Truss-system*	SIFCON	?	S	Tensile Compress. strength	Truss members		Netherlands	Van Mier et al, '95
Roofing tiles (extruded or Hatschek)	cellul. pp wollas.	4-5	N	Shrinkage crack res. Tensile strength Toughness MOR	Durability	Life-cost No steel reinf. poss. Light-weight	Denmark	Glavind & Stang, '94
Thin sheet products for cladding	asbestos cellul. pp glass PVA carbon	varies	N	Shrinkage crack res. Tensile strength Toughness MOR	Durability	Life-cost No steel reinf. poss. Light-Weight	Europe	Bentur, A., '95
Ferrocement column	steel carbon	1 5	N	First crack res. MOR	Corrosion res. Durability Red. in crack width	Life-cost	Japan	Shirai and Ohama, '95
Packaging and storage nuclear waste	Metglas		N	Microcrack resist.	Contain radioactivity Durability	300 yr. containers	France	St. Gobain lit. Sogefibre
Stair treads	PVA	2	SS	Low density Strength Toughness	Rust resistance Light-weight Boltable	Life-cost	Japan (Kajima)	Yurugi et al, '91 KaTRI Broc.

*Experimental.

be gaining ground with documented successes in various parts of the world. The sluggish growth in FRC applications is influenced by many factors, including: 1. the high cost of fiber compared with other constituents of concrete; 2. the cost-sensitive nature of the construction industry; 3. the mixed experience in the use of FRC in certain applications; and 4. the unclear linkage between fiber and concrete element performance. Both end-users and fiber suppliers need to be realistic in what each type of fiber can do to concrete element performance. Research is needed to continuously improve the benefits brought about by fibers, while reducing the cost of fiber applications. Users need to be educated that part of the fiber cost can be offset by reduction or elimination of other costs using conventional concrete without fibers, as described in this section.

The cost pressure will always be present. One way of overcoming this pressure is to continuously and systematically enhance the benefit/cost ratio. Structural load-bearing capacity of fibers appears to be a significant benefit reaching beyond laboratory curiosity and emerging in industrial settings at the present time. Fibers designed with this function in mind, with proper surface treatment for fresh (FRC rheological) properties and hardened composite properties, can contribute significantly to future advanced structural members. The emerging trend of structural applications of FRC is described in the next section.

STRUCTURAL APPLICATIONS OF FRC

At present, despite much research in the laboratory, the use of FRC in load-carrying structural members is very limited. Using fibers to carry load across cracks in a hardened concrete in structural design is still a novel practice. This is because of a lack of clear understanding in how fibers contribute to load-carrying capacity, confusion between material and structural strengths, lack of structural design guidelines for FRC members, uncertain cost/benefit ratio, and insufficient material property specification, characterization, and test standards. These deficiencies not only limit the broader use of fibers in structural applications, but also make it difficult for fiber suppliers to optimize their fibers for concrete structural applications.

Research findings in the last decade clearly establish that ductility of certain structural members can be greatly enhanced with the use of fibers. In addition, fibers generally favor improve-

ments in first crack and ultimate member strength, impact resistance, and shear resistance. If properly designed, fibers can add to member structural performance even when used together with conventional steel main reinforcements (re-bars). Some highlights of these laboratory findings are summarized in the section below.

Currently, several construction projects are contemplating the application of fibers in load-carrying concrete members. The concrete tunneling project in Japan appears to be the most advanced one, both in time and in implementing the fiber load-carrying capacity into the design calculation. This project is described in a later section. This case, together with the laboratory studies of FRC structural members, suggest that the σ - δ relation is the most useful property characterization of FRCs for structural design. Means of FRC structural performance comparison are indicated at the end of this section.

Laboratory Studies of Structural Applications of FRC

There have been a large amount of laboratory studies of applications of FRCs in R/C and prestressed concrete structural members. This section summarizes the highlights of these studies, which demonstrate without a doubt that fibers can be effective in enhancing structural strength and ductility in load-carrying members. These studies include members under flexural, shear, torsion, and combined loads. Additionally, structural component responses under cyclic load and bond property of reinforcing steel bars have also been studied. Most of these studies have been limited to steel fibers. More detailed descriptions of the test methods and parameters as well as the original references can be found in Balaguru and Shah.³

In flexural R/C members, the addition of fibers improves the modulus of rupture (bending strength). Especially in over-reinforced concrete beams, the significant gain appears to be in the enhancement of post-peak structural ductility (Fig. 6), a quantity valued by structural engineers for safety reasons. This ductility improvement is likely a result of the delay in compression crushing by increasing the compression strain capacity due to fiber reinforcement. The potential for over-reinforcement is greater when higher strength steel or FRP (fiber reinforced plastic rod) is used as reinforcement. For under-reinforced beams or beams with no main reinforcement at all, flexural strength enhancement and post-peak ductility

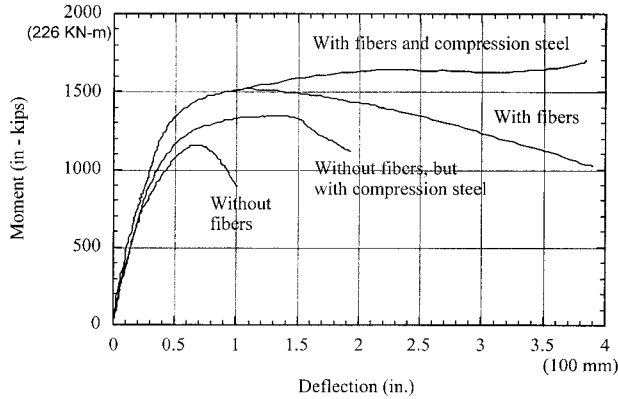

Figure 6 Enhancement of structural ductility in R/C FRC beam.⁵

are associated with fiber bridging action on the tensile cracks activated when the beam is flexed to beyond the elastic limit. Proper design of R/C and prestressed beams with deliberate exploitation of advantages afforded by fibers requires further research.

There is evidence that fibers can be effective replacements for shear steel stirrups commonly used in R/C beams and other structural elements such as shear keys and corbels. Shear failure by diagonal cracking is often structurally unstable. Shear fracture is prevented in current structural design practice by the use of “shear reinforcements”—often in the form of U-shaped stirrups or helical windings in cylindrical-shaped elements. However, the use of shear reinforcements are labor intensive and reinforcement effects are directional and discrete (location-wise). As a result, replacement of shear steel reinforcement by fibers has been attempted. As soon as diagonal cracks are formed, fibers are activated to provide bridging across the concrete cracks. If this bridging action and the resulting shear resistance are high enough, the more ductile bending failure mode can be restored and the brittle shear fracture failure can be avoided.⁶ The effect of fibers on shear strength of R/C beams depends on the span/depth ratio, but can be as much as 100% improvement (Fig. 7).

The failure mode of torsion members is similar to that under direct shear, in the sense that diagonal cracks form in response to the principal tensile stress. Hoop reinforcement or helical windings are conventionally provided to resist torsion failure. Again, fibers can be very effective in bridging against the opening of these diagonal cracks, and delay the ultimate failure of the structural member, as shown in Figure 8.

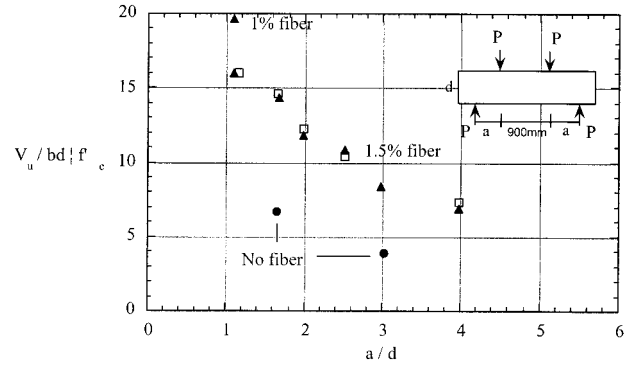

Figure 7 Enhancement of shear capacity of structural elements by fiber reinforcement.⁷

Fibers are perhaps most effective for structural members under combined bending, shear, and torsion loads (e.g., a concrete utility pole under wind loads and electric wire tension). This is because the combined load often makes the exact location of concrete cracking difficult to predict. Even if predictable, the changing direction of the principal tensile stress makes conventional continuous steel reinforcement difficult to place in optimal orientation. Instead, fibers with its virtual advantage of random orientation bridge tensile cracks whichever directions they form and wherever they form on the structural member. Figure 9 shows an example of the effect of fibers on the behavior of a member under combined torsion, bending, and shear.

In R/C structures or prestressed concrete structural components, the bond between concrete and steel reinforcement is paramount. When bond is lost, the concrete/steel composite action also vanishes. The loss of bond is associated with the emanation of radial cracks from deformed slugs

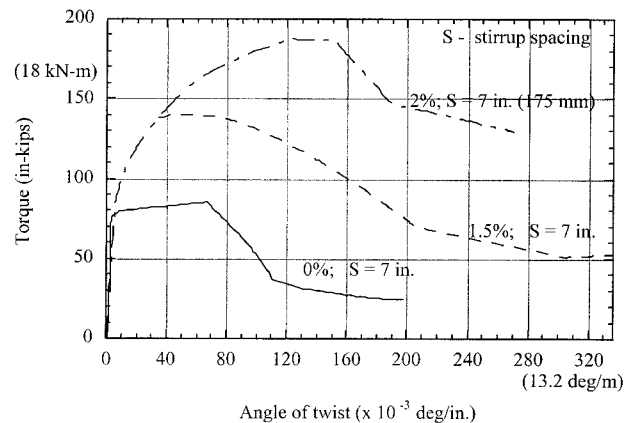

Figure 8 Enhancement of torsional capacity of structural elements by fiber reinforcement.⁸

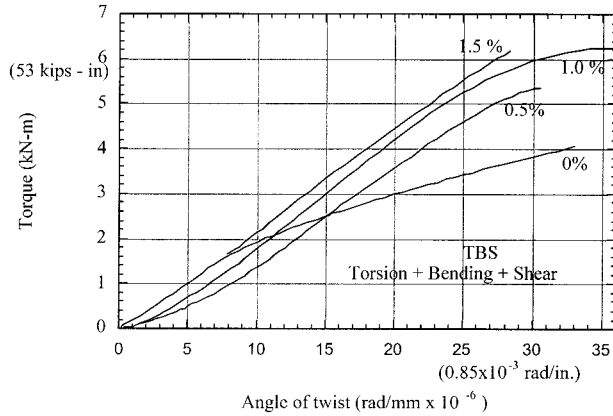

Figure 9 Enhancement of structural capacity by fiber reinforcement under combined loading.⁹

along the length of a reinforcing bar. There is experimental evidence that bond-slip behavior can be drastically altered by the use of fibers. A factor of 2–5 increase in bond strength, and 20 times in slip at peak pullout load, have been recorded.¹⁰ The mechanism could be attributed to enhanced resistance to radial crack growth due to fiber bridging effect. Figure 10 shows that the commonly observed softening pull-out load-slip relationship can even be altered to a hardening response when cracking of the concrete surrounding the re-bar is suppressed. In this case illustrated, a large amount of fibers has been used. If the radial cracks are arrested because of fiber bridging, composite action (between the FRC and the re-bar) is restored, again leading to improved structural capacity.

Not much study has been made on the influence of fibers on columns. This may be because of the general thinking that the structural performance of columns, being mainly under compres-

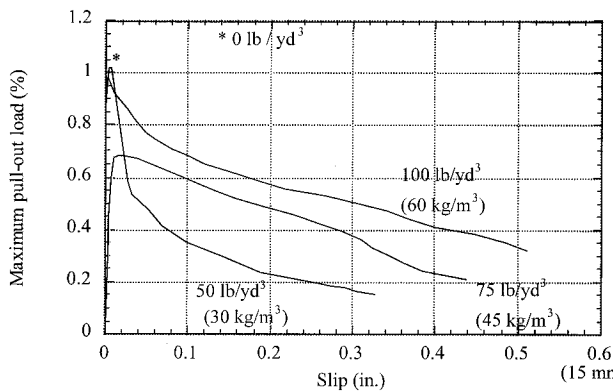

Figure 10 Influence of fibers on steel re-bar load-slip.¹¹

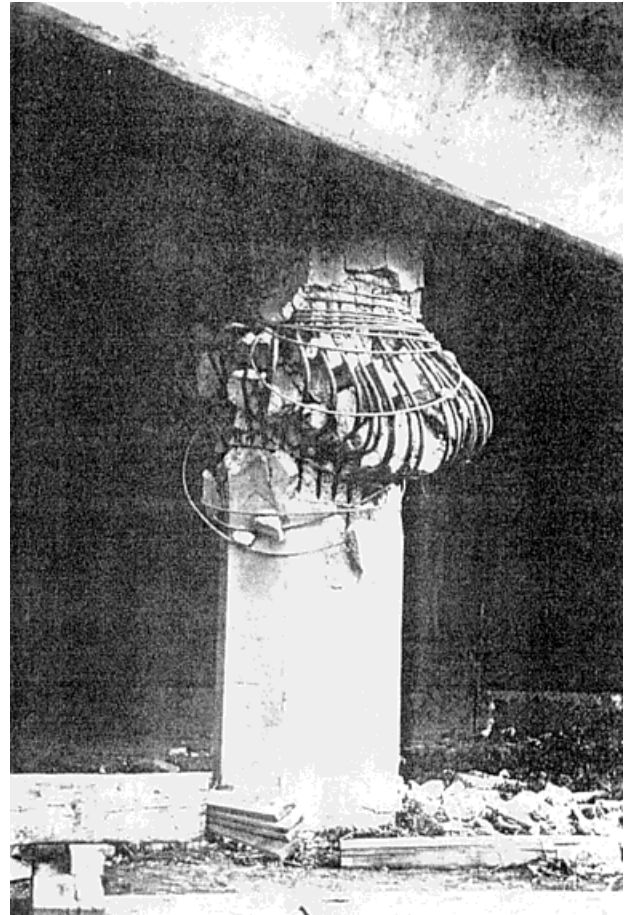

Figure 11 Failed bridge column in the Northridge earthquake in California.

sive load, cannot be improved by the use of fibers. Also, there is a common belief that columns “properly” reinforced axially and with hoop steel acting as confinement should not fail. Unfortunately, the recent Northridge earthquake in California and the Kobe earthquake in Japan shatter these concepts. Figure 11 shows an example of a typical failed bridge column. Brittle spalling of the concrete cover combined with fracturing of the confining steel cause complete disintegration of the column when the axial steel buckles. It may be expected that fiber reinforcement providing innate toughness to the concrete should defer the spalling of the concrete cover, leading to ductility performance improvement of the column. This use of FRC is being investigated by a number of research groups at present. Recently, Horii et al.⁶ suggested that the shear capacity of short columns could be enhanced by delaying the propagation of shear fracture by fiber bridging action.

The various modes of failure under different load types described above are summarized in

Table II, which schematically illustrates how the fiber bridging actions across concrete cracks or in damage zones serve to enhance structural performance.

Despite extensive laboratory demonstrations of the usefulness of fibers in structural applications as described above, actual use of fibers in the construction industry for structural purposes is still limited. Among the many reasons, design methods and specifications are severely lacking in the use of FRC for structural member applications. This makes it difficult for structural designers to adopt FRC as a structural material. In addition, current code requirements may act as deterrent of fiber usage. However, certain semi-structural elements, such as building wall panels (see Table I for others labeled SS) provide experience and confidence in fiber introduction to structural elements for loading-carrying functions. In addition, there are a few projects around the world that are pioneering the use of FRC as a structural material. These structures are designed specifically taking into account the unique properties of FRCs, and establish the near-term trend of fiber applications in the construction industry. Finally, a number of countries are now moving toward performance-based design, which is expected to allow more flexibility in materials specifications.

A Case Study of Structural Design with FRC

To meet the demands of urban traffic, Japan has developed the extruded concrete lining (ECL) technology for underground railroads in which tunnels are simultaneously excavated and wall linings constructed.^{12,13} As a result, the tunnels can be constructed safe, fast, economical, and with minimum disturbance to the urban environment. In addition, this one-step excavation–extrusion method reduces labor and enhances working conditions. Steel FRC was chosen as the material for the wall lining, which must conform to the contour of the excavated rock wall.

The performance requirements for the high-quality linings include reduction of lining thickness and resistance to bending load. The bending action is a result of external crushing pressure on the ring-like concrete lining. It turns out that the material property defining the ultimate limit state of the tunnel section is the modulus of rupture (MOR) which captures the critical flexural load and explicitly takes into account the lining thickness. In 1992, the Japan Railway Construction Public Corporation published the tunnel lin-

ing design guideline *Recommendation for Design and Construction of Extruded Concrete Lining Method*.

According to Horii and Nanakorn,¹² this is the first fracture mechanics-based design recommendation because it recognizes the contribution of crack bridging fibers in stabilizing the tensile crack which eventually leads to flexural failure. This recognition properly accounts for the structural load-bearing capacity of fibers in FRC structure. The ECL constitutes a fine real-life example of the structural application of fibers in concrete.

Figure 12 shows the stress–strain distribution for calculating section strength.¹³ The factored moment resistance is then given by:

$$M_{ud} = \int_{-h/2}^{h/2} \sigma'(y) \cdot y \cdot b \cdot dy / \gamma_b \quad (1)$$



where h = lining thickness; b = unit width; and γ_b = member coefficient. The important point to notice in Figure 12 is the tensile load carried by the fibers on the cracked part. This tensile load-carrying capacity of fibers across a concrete crack has been studied extensively^{14–16} and is a function of the crack opening magnitude. Hence, the tensile stress is maximum near the crack tip and decays toward the crack mouth. The detail stress profile naturally depends on the specific fiber type and content, as well as the interface property. This information is contained in a fundamental composite property known as the tension-softening curve, or $\sigma(\delta)$. Strictly speaking, the $\sigma'(y)$ term in eq. (1) should be written as $\sigma[\delta(y)]$ along the crack line. For the steel fibers and the bending load configuration, the simplified constant value f_{tfd} (corresponding to the crack mouth opening value) is found to be a good approximation of the actual stress distribution based on more accurate finite element analysis.¹² This implies that the crack opening at failure must remain relatively small compared with the fiber length.

Figure 13 shows the extruded concrete lining in the Ojiya Headrace tunnel constructed in 1991. The tunnel has an inner diameter of 7.6 m and lining thickness of 0.4 m. The FRC contains 1% of straight indented steel fibers 0.6 mm in diameter and 25 mm long. Part of the ECL boring/lining machine is shown in Figure 14.

Structural Application/Design and Composite Properties

The case study described above illustrates two aspects that should form a common basis for

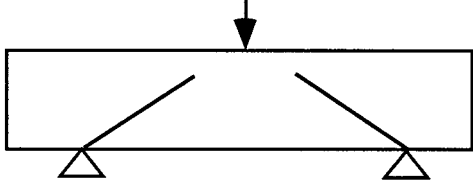
Table II Failure Modes of Typical Structural Members and Performance Improvements by Fiber

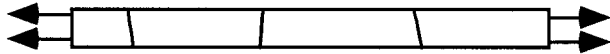
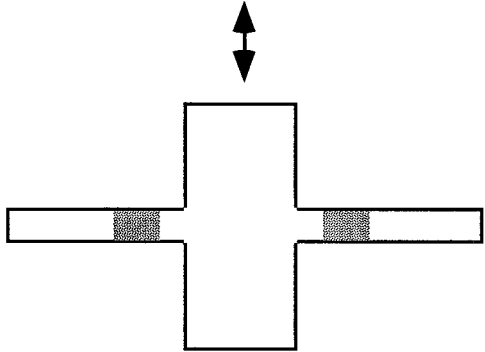
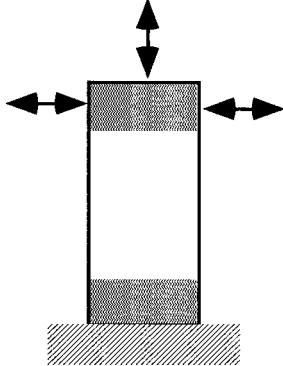
Structural Member/Load	Example Application	Performance Modification by Fiber
<p>Flexural members</p> 	<p>Tunnel linings Beams Slabs</p>	<p>Bending strength Pre-peak and post-peak ductility</p>
<p>Shear members</p> 	<p>Bridge decks Corbels Keys in segmental construction Steel anchors in concrete members</p>	<p>Shear capacity Post-cracking safety</p>
<p>Torsional members</p> 	<p>Poles Bridge decks</p>	<p>Torsional capacity Post-cracking safety</p>
<p>Uniaxial tension members</p> 	<p>Pavements</p>	<p>Expand joint spacing</p>
<p>Beam-column connections</p> 	<p>Building frames</p>	<p>Seismic resistance Reduce reinforcement and congestion</p>
<p>Column</p> 	<p>Building columns Bridge columns</p>	<p>Seismic resistance Reduce spalling and enhance steel confinement</p>

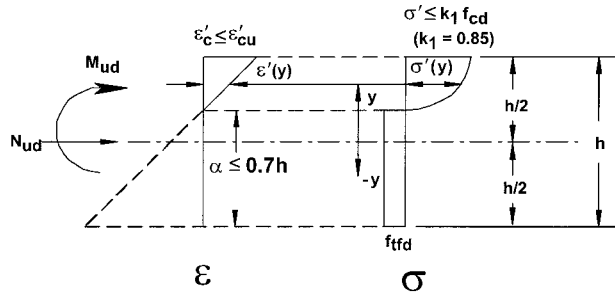

Figure 12 Stress-strain profile in lining section.¹³

structural applications of FRCs where tensile cracking governs the structural behavior. The first is: the structural design process directly accounts for the load-carrying capability of the fibers. For the tunnel linings, the moment resistance M_{ud} takes into account the tensile load borne by the fibers across the concrete crack under bending load. This concept can be summarized in a generalized form:

Structural capacity

$$= \text{fcn}(\text{structural geometry, load configuration, concrete properties; } \sigma-\delta) \quad (2)$$

This basic design concept should be applicable even in R/C or prestressed concrete structures. When tensile cracks form, standard dowel action by re-bars and/or aggregate interlocking should be supplemented by fiber bridging action via the $\sigma-\delta$ relation. If the compressive properties are modified by fiber addition, it should be reflected in the concrete properties term in eq. (2).

Thus, the $\sigma-\delta$ relation serves as the basic representation of fiber contribution to the structural capacity. This second aspect in the structural design procedure in fact underlies the fundamental



Figure 13 ECL in Ojiya Headrace tunnel.¹³

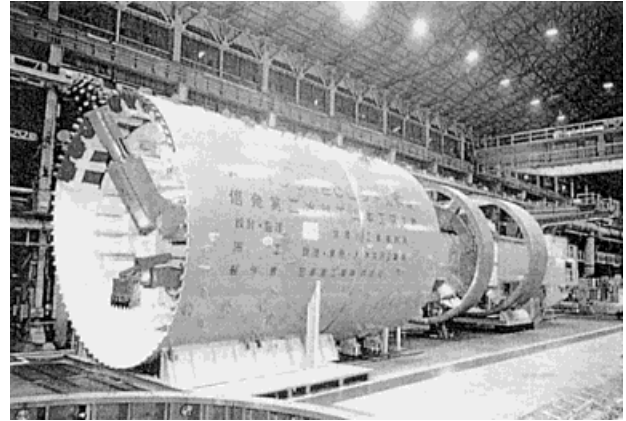

Figure 14 ECL boring/lining machine.

basis for most structural exploitation of fibers. The failure modes and the action of fibers in assisting the load carrying capacity in various structural members described above and summarized in Table II further support this statement.

At present, there are few design guidelines in using FRC for structural applications. When there are, material property requirement is often formulated in terms of FRC toughness index (TI), such as that defined in ASTM C1018-89. Whereas such specification is reasonable for structural application in which the element is loaded in similar size and configuration as those specified in the ASTM TI test, the usefulness of TI in general is doubtful. For example, TI has little relevance for structural design of column or shear structural members. This is because while the TI reflects the fiber bridging effect, cracking and its relation to structural capacity are highly sensitive to the structural loading and geometry. TI is useful for ranking materials in energy absorption under flexural loading conditions, but is of limited value in general structural design procedures.

Material specification should not be too restrictive as to choke innovations. Specifications in terms of fundamental composite properties may provide the best means of properly meeting structural performance needs and determining the required fiber, interface, and matrix characteristics.

As a fundamental property for structural design, it is necessary to have reliable procedures for experimental testing of the $\sigma-\delta$ relation for a given FRC. Such test results can serve as design input to take into account the fiber contribution to structural performance as discussed above. A number of researchers have published results of uniaxial¹⁷⁻¹⁹ and fracture-based²⁰ tests for the $\sigma-\delta$ relation. Efforts are being made for simpler

Table III Fiber and Interface Parameters

Fiber Type	L_f/d_f	τ (MPa)	g
Steel	100	4	2
Olefin	75	2	1–2
Carbon	300	2–5	1
Polyethylene	340	0.5–5	2

and more robust (“industrial strength”) test procedures for the σ – δ relation.¹²

A limitation of experimental determination of the σ – δ relation in FRC is that optimization of fiber type, geometry, and cement or concrete mix design must be achieved in a trial-and-error manner. It would be far preferable to have an analytic relationship such as:

$$\sigma = \sigma(\delta; \text{fiber, interface, and matrix characteristics}) \quad (3)$$

so that it is possible to choose specific fiber type, geometry, content, as well as interface characteristics and cementitious matrix mix design to control the σ – δ relation, and hence the structural performance. A simple form of eq. (3) is available,^{15,21} based on micromechanical model of the bridging mechanism of randomly oriented short straight fibers:

$$\sigma = \frac{1}{2} V_f g \tau \left(\frac{L_f}{d_f} \right) \left[1 - \frac{\delta}{L_f/2} \right]^2 \quad (4)$$

where V_f , L_f , and d_f are the fiber volume fraction, length, and diameter, respectively, and g and τ are interface parameters.¹⁵ Some typical values of these parameters for polypropylene, polyethylene, carbon, and steel fibers attempted in use as structural reinforcements can be found in Table III. An example of the predictability of this σ – δ relation is shown in Figure 15 together with experimental data from Visalvanich and Naaman,¹⁶ and Wang and Backer.¹⁹

From eq. (4), it can be seen that fiber performance comes through the term

$$\sigma_o = \frac{1}{2} V_f g \tau \left(\frac{L_f}{d_f} \right) \quad (5)$$

that represents the peak value of the σ – δ relation. The most important fiber parameter is the aspect ratio L_f/d_f . In general, fiber length L_f can easily vary according to needs. Fiber diameter varies

within a certain range depending on the fiber type. For example, carbon fibers are typically made in the 8–20-micron diameter range, synthetic fibers are typically made in the 10–200-micron diameter range, and steel fibers are typically made in the 150–500-micron range. Fibers with diameters outside these ranges for the various materials have been made; however, loss in tensile property and significant increase in cost result. Thus, from the standpoint of eq. (5), with respect to fiber aspect ratio, synthetic and carbon fibers have the advantage over steel. It should be noted that, apart from reinforcing performance, the aspect ratio of fibers also influences other nonstructural but nevertheless important application aspects. For example, large fiber aspect ratio can severely penalize workability of the fresh mix with attendant fiber balling and defect introduction into the composite. Furthermore, for some fibers, small diameter may create handling problems (itching or pinching of skin) to workers.

Another important parameter in eq. (5) is the interface bond τ . A number of techniques are available for interface bond modifications, including the classes of fiber deformation, fiber surface modification, and interface transition zone densification. Each has their advantages and limitations. For steel fibers, fiber deformation in the form of crimping, end-hooking, end-buttoning are common examples. For synthetic fibers and carbon fibers, surface modification techniques such as plasma treatment, corona treatment, or surface coating are possible. Interface transition zone densification requires direct modification of the cement matrix, usually by introduction of microfillers such as microsilica (or silica fumes). A

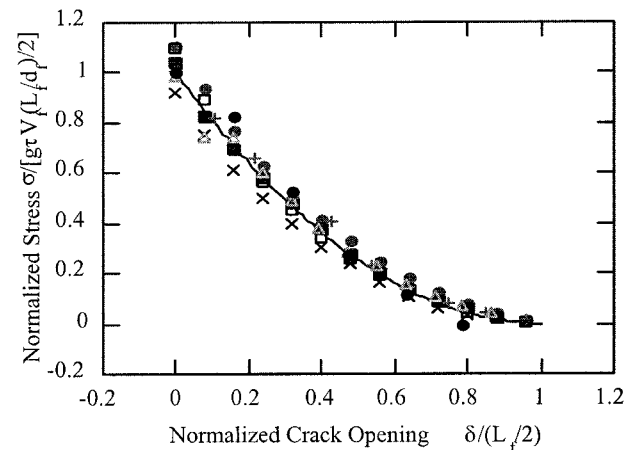

Figure 15 Normalized measured and predicted σ – δ relation for eight different composites.¹⁵

review of various techniques for controlling interface bond and their effectiveness can be found in Li and Stang.²²

Equation (5) does not account for the influence of fiber strength. This is because in deriving eq. (5), it has been assumed that the fiber length is short enough and/or the interface bond is low enough such that the pullout load never exceeds the fiber strength. Hence, fibers are pulled out instead of rupture. Otherwise, when fiber length exceeds the critical length, a modified form of eq. (5) needs to be derived. A more sophisticated version of eq. (5) which does account for fiber rupture can be found in Maalej et al. (1995).

Another limitation of eq. (5) is that fibers can rupture under bending even when the tensile stress on the fiber is not high. Because discontinuous fibers are generally used in random orientation, fibers can be expected to bend whenever they cross in matrix crack. Once a fiber fails in bending, the contribution to crack bridging is lost. The amount of bending a fiber can tolerate can be directly related to the tensile strain capacity of the fiber. Thus, higher fiber elongation capacity is preferable to withstand bending rupture. In this regard, polymer fibers (elongation $\sim 3\text{--}20\%$) and metallic fibers ($\sim 2\text{--}4\%$) will outperform most carbon fibers ($<2\%$).

For some structural properties, the influence of fibers can exert itself via the fracture toughness associated with energy absorbed by fiber pullout. This energy can be determined from eq. (4), and results in (Li, 1992):

$$G_c = \frac{1}{2} g \tau V_f \frac{L_f^2}{d_f} \quad (6)$$

The fracture energy expressed by eq. (6) is particularly useful when composite properties associated with energy absorption govern structural performance. Structures with loading such as that from impact or with geometry which results in stress concentration leading to a high potential of fracture failure will benefit from this material property.

In structural applications, it is often desirable to express the structural ductility in a simple manner. Unfortunately, structural ductility is often described using different parameters for different structural applications, making it difficult to compare structural ductility with different materials. One measure used by researchers in recent years which best approximates structural brittleness (inverse of ductility) in the fracture

mechanics sense is the “brittleness number” (Bache, 1989) n , which represents the ratio between structural size L to a material characteristic length l_{ch} (Hillerborg et al., 1976). Hence $n = L/l_{ch}$. (However, the appropriateness of using l_{ch} in R/C members becomes less clear.) The material characteristic length can be related to composite modulus E , tensile strength σ_t , and the fracture energy G_c :

$$l_{ch} = \frac{EG_c}{\sigma_t^2} \quad (7)$$

For a structure with large size or that uses a material with small characteristic length, the structure is expected to fail in a brittle manner. For a structure with small size or that uses a material with large characteristic length, the structure is expected to fail in a ductile manner.

As noted above, fibers can have a significant effect on G_c . For this reason, fibers can alter the structural “brittleness number” via the material characteristic length.

The estimated values of the parameters measuring structural values described above are given in Table IV for a variety of fiber-reinforced concretes. These FRCs have been used in structural or at least semistructural applications. Also included are some “high-performance” materials that are targeted to influence properties of structural elements. These include CRC from Aalborg Portland Cement in Denmark, RPC from Bouygues in France, SIFCON from the United States, and ECC being investigated in the ACE-MRL at the University of Michigan. As indicated in eqs. (5–7), the parameters listed in Table IV are dependent on fiber mechanical and geometric properties, as well as fiber content. The calculated values are based on typical values of fibers used in practice today. Otherwise, the structural measures are based on direct or indirect experimental determinations.

From Table IV, it can be seen that concrete without fiber reinforcement is brittle and has low values of toughness G_c and material characteristic length l_{ch} . In contrast, FRCs have G_c and l_{ch} values which are one to four orders of magnitude larger. These improvements are directly responsible for the load-carrying capacity and ductility in structural members described in the previous sections. Among the current steel, carbon and polymer FRCs, steel fibers provide the greatest improvements in G_c and l_{ch} values. It is not surprising that at the present time, steel remains the

Table IV Structural Properties of Some FRCs

FRC	σ_o (MPa)	σ_t (MPa)	ε_t (%)	E (GPa)	G_c (kJ/m ²)	l_{ch} (m)	Reference
Normal-strength concrete	—	2–5	0.01	15–30	0.1–0.2	0.25–0.4	Mishra, 1995; Van Mier et al., 1995
Steel FRC ($V_f = 1\%$ hooked end)	4 ^a	4.5	0.05–0.5	32.5	5	8	Li, 1998
Carbon FRC ($V_f = 2\%$)	5.5	5	0.1–0.2	5.6	1–3	0.2–0.7	Akihama et al., 1986
Polymer FRC ($V_f = 1\%$ olefin)	0.75–1.5 ^a	4.5 ^b	~ 0.1	30	1–4 ^c	1.5–6	Van Mier et al., 1995
SIFCON ($V_f = 4\text{--}20\%$ steel)	20–35	6–32 ^d	0.5	30–70	20–30 ^e	2–17	Naaman, 1991
CRC ($V_f = 6\%$ steel, together with steel bars)	40	120	~ 1–2	100	1200 ^e	8.3	Bache, 1989
RPC 200 ($V_f = 2.4\%$ steel)	9.6	10–24 ^d	0.5–0.7	54–60	15–40 ^e	4.2–8.1	Richard and Cheyrezy, 1992
ECC ($V_f = 2\%$ PE)	4.5–8 ^f	2.5	3–6	22–35	27	95–150	Li, 1998

^a Estimated by using eq. (5) and fiber and interfacial parameters in Table III.

^b Assumed same as steel FRC, based on bend test comparison with SFRC in Van Mier et al., 1995.

^c Estimated from toughness index measurement.

^d Estimated from MOR/2.5.

^e Estimate not from fracture test.

^f Higher value from fiber with surface treatment.

choice of fibers for structural applications. Indeed, many attempts have been made to incorporate large amounts of steel fibers into concrete to make high-performance composites. SIFCON (slurry infiltrated fiber concrete) is a result of infiltrating a large amount of steel fibers in a bed with a very fluid mortar slurry. CRC (compact reinforced concrete) takes this a step further by also incorporating a large amount of continuous steel reinforcement of 10–20% by volume (Bache, 1989). In this case, compaction is achieved by high-frequency vibration applied directly onto the steel reinforcements, aided by careful grading of the concrete mix. Despite the extremely good performance of SIFCON and CRC, their commercial success appears to be limited to smaller structural elements or mechanical parts, possibly because of limitations imposed by weight and cost associated with their high fiber content, as well as penalties imposed by special processing requirements. RPC (reactive powder concrete) 200, the newest entry into this category of high-performance FRCs, appears to have the highest potential of commercial success exactly because it uses a smaller amount of fiber and makes use of a better-designed matrix material. The very fine grain concrete with “aggregates” in the micron range (really silica powder <600 μm) resembles ceramics especially when heat and/or pressure is

applied. Whether these special processing needs and associated costs will become obstacles to commercial applications of RPC in large-scale structural members remains to be seen. RPC 200 has been proposed for use in prestressed concrete structures with no passive steel reinforcement (Richard and Cheyrezy, 1992).

The ECC (engineered cementitious composite) developed at the ACE-MRL at the University of Michigan (Li, 1993) has the unusual behavior of strain-hardening rather than tension-softening as occurs in most of the other FRCs discussed, when tested under uniaxial tension. Although the current tensile and compressive strengths of ECC are similar to those of high-strength concrete, the ductility and energy absorption capabilities as measured by the tensile strain, ε_t , G_c and l_{ch} are unsurpassed, despite the low fiber volume fraction. More on this material is described in the next section.

STRAIN-HARDENING CEMENTITIOUS COMPOSITES: AN EMERGING TECHNOLOGY

It has long been recognized that concrete is a brittle material, and must therefore be used together with steel in structural applications. At-

tempts at making concrete truly ductile with high tensile strain capacity by the use of fibers have been met with limited success. The major advancement is that composite toughness can be greatly enhanced, and utilized in structural members. However, this toughness is derived from the energy absorption of fiber pullout. In reality, the structure would almost always fail at maximum crack opening much smaller than half the fiber length, so that full fiber pullout cannot be achieved. As a result, the G_c value discussed above is cut short. And FRC toughness which depends on G_c will not be fully realized. Furthermore, in a uniaxial tensile test, FRCs exhibit what is known as the “quasi-brittle” material behavior. This means that, after initial tensile cracking of the concrete matrix, tension-softening (Fig. 15) is followed by a continuously widening crack. Current FRCs, including many of the “high-performance” types, belong to this category. Obviously, a much more desirable response will be that of a tension strain-hardening response like that of structural steel.

In the past, this kind of strain-hardening response has been achieved with (a) large amount of fibers, such as 10–20% by volume, or (b) long continuous fibers, or both. Strain-hardening has been demonstrated with steel, carbon, glass, and polymer fibers in cementitious matrices. However, large amounts of fibers imply high cost, and long continuous fibers make standard processing difficult. These limitations have more or less prevented these materials from being used in any large quantities industrially. In recent years, advances in micromechanics, fibers, and processing have enabled strain-hardening materials to be achieved at relatively low fiber volume fraction, say less than 2%. The following subsections describe an ECC that has been designed to overcome the above problems while demonstrating good potentials for structural applications. Some applications investigations are also presented. Finally, the basis for achieving these unusual properties is briefly summarized.

Engineered Cementitious Composites

Recent research at the ACE-MRL at the University of Michigan has focused on developing fiber-reinforced cementitious composites having the following attributes:

1. Flexible processing—can be used in precast or cast-in-place applications with no

requirement of very special processing machinery.

2. Short fibers of moderate volume fraction—to maintain flexible processing, reduce cost and weight.
3. Isotropic properties—no weak planes under multiaxial loading conditions in bulk structures.
4. High performance—leading to significant improvements in strength, ductility, fracture toughness, and exhibit pseudo-strain-hardening.

The fourth attribute appears to be exclusive of the others, and typical FRCs satisfy some but not all of these attributes. Conventionally, research has focused on studying the property dependence of FRC on one or two parameters at a time, typically the fiber volume fraction, or fiber length. However, it is now well known that composite properties depend on three groups of constituent properties—the fiber, matrix, and interface properties. The importance of this is the recognition that fiber volume fraction, for example, is only one of more than 10 constituent parameters under our control for material engineering.

It is not enough to understand the individual influence of each parameter on composite properties, which can be (at least in principle) established empirically. Composite optimization requires that the combined influence of all relevant parameters on composite properties be known. Composite optimization can lead to a composite with excellent performance with only moderate fiber volume fraction, thus meeting the favorable characteristics of an ideal FRC described above.

To establish the combined influence of the constituent parameters on composite properties, it is necessary to develop a fundamental understanding of the micromechanisms that govern a given material property. Based on this understanding, it will be possible to identify the material microstructure and associated properties that control composite behavior. Hence, micromechanics serves to establish the link between material constituents and composite properties. The resulting information can be used to advantage for composite design. When fully developed, micromechanics can also be utilized as a tool for material property customization. As a result of using the micromechanical tools for microstructure design, an ECC material has been developed that satisfies all four favorable attributes identified above.

An example of the uniaxial tensile stress-strain curve of this ECC is shown in Figure 16.

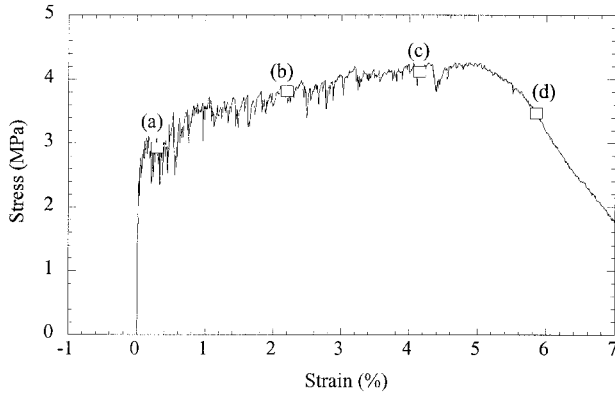

Figure 16 Tensile stress–strain relation for a pseudo-strain-hardening ECC manufactured with a regular mixing and casting process.¹⁵

The tensile strain capacity of this particular specimen reaches 5%, with extremely high toughness and characteristic length. Damage evolution at

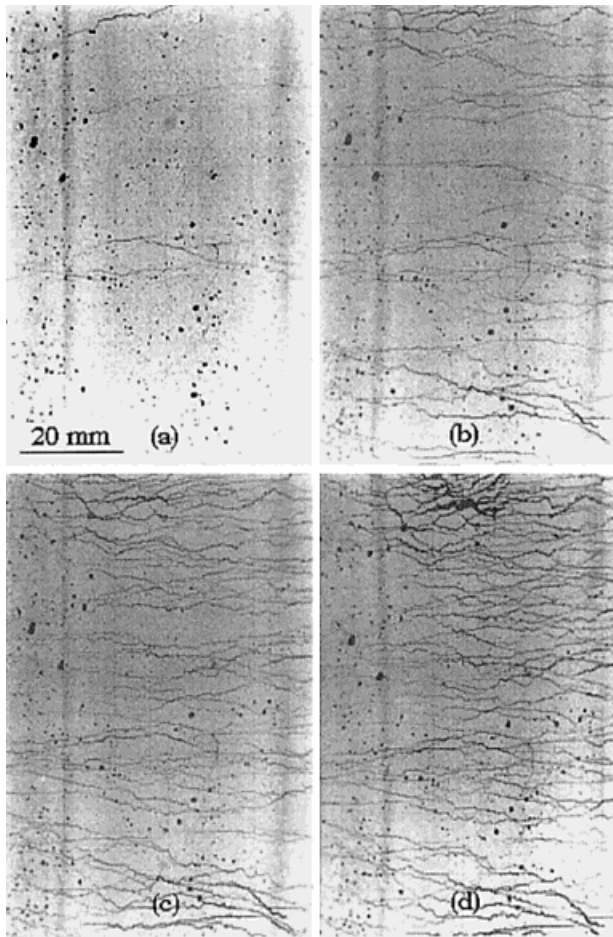

Figure 17 Damage evolution as a function of deformation on uniaxial tensile specimens (a) $\epsilon = 0.3\%$, (b) $\epsilon = 2.2\%$, (c) $\epsilon = 4.2\%$, and (d) “ ϵ ” = 5.9%.¹⁵

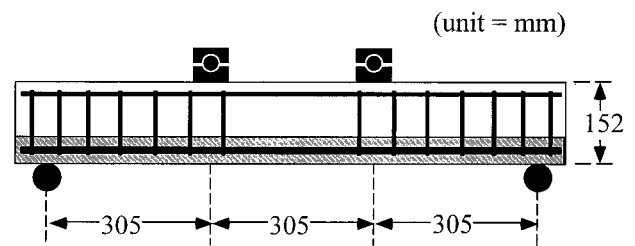
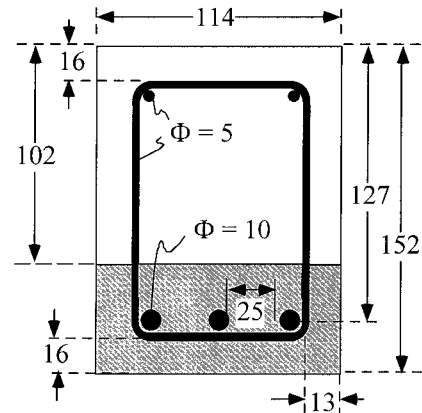

Figure 18 Geometry of the R/C beam with ECC layer and reinforcement details.

four stages of the multiple cracking process is shown in Figure 17. Further properties of this composite can be found in Table IV.

Structural Applications of ECC

Highlights of three investigations into applications of the ECC are briefly summarized in this contribution. The three applications are: 1. structural durability of R/C flexural members, 2. energy absorption capacity of plastic hinge in a beam-column connection, and 3. shear performance of R/ECC elements.

Structural Durability of R/C Flexural Members

The durability of R/C members is often compromised by tensile cracking under flexural loads, followed by steel corrosion and concrete cover spalling. A new design for R/C flexural members for the purpose of improving their durability was proposed (Maalej and Li, 1994). The design makes use of an ECC layer to serve as the concrete cover. A regular R/C beam (serves as control specimen) and the R/C beam with a layer of ECC substituted for the concrete (Fig. 18) that surrounds the main flexural reinforcement were tested under four-point flexural loading. Specimen and loading con-

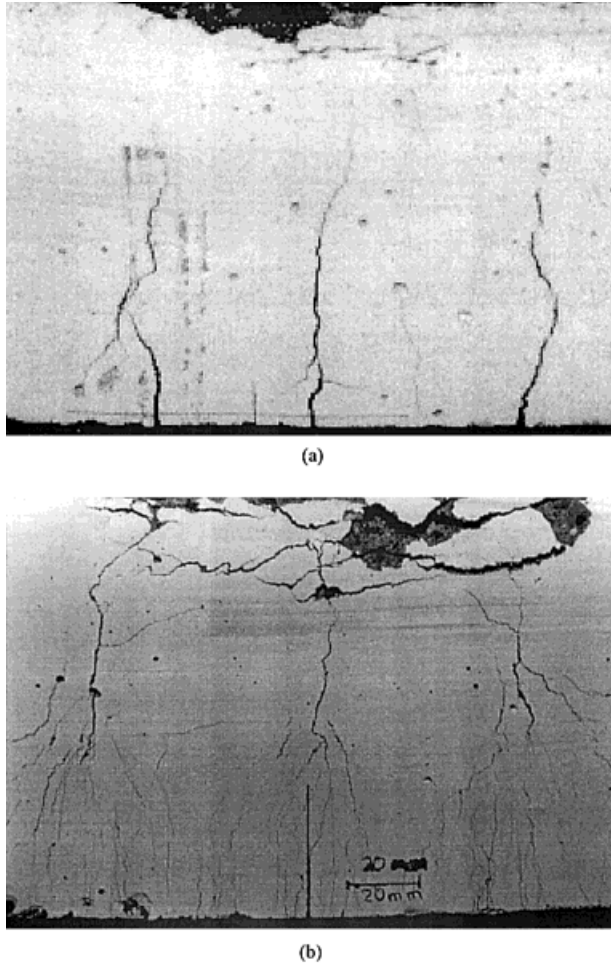

Figure 19 Crack pattern. (a) Control R/C beam; (b) R/C beam with ECC layer.

figuration details can be found in Maalej and Li (1994).

The crack patterns that develop in the control regular R/C beam [Fig. 19(a)] and the ECC layered beam [Fig. 19(b)] are distinctly different. As the R/C beam with the ECC layer was loaded, the first crack could be seen above the ECC layer but difficult to see in the ECC layer. As the load was further increased, the cracks that developed in the concrete material diffused into many fine cracks when they met the ECC material.

Figure 20 shows the moment curvature and crack width curvature diagrams for both beams. There is no significant difference between the moment curvature response of the two beams. The crack width-curvature response of the two beams is, however, significantly different. The crack width in the control specimen increases almost linearly as a function of curvature. At peak load, the width of the crack is approximately equal to

1.52 mm. If the beam is loaded 20% beyond yield, the crack width in the beam reaches the American Concrete Institute crack-width limit for interior exposure (0.406 mm). Any cracks of width larger than this limit may result in a high rate of reinforcement corrosion. Overload of a properly designed member (satisfying crack width criteria under service load) can drive cracks significantly wider resulting in eventual durability problems. Figure 20 shows that for a given curvature the crack width measured on the beam with the ECC layer is much smaller than that measured on the control R/C beam. At ultimate load, the crack width reaches 0.19 mm. Also, the strain measured in the ECC material at the bottom of the beam was 0.026, which is smaller than the ultimate strain capacity of the material. This experiment demonstrates that the strain-hardening ECC cover provides improved integrity over regular concrete in the R/C flexural element.

Energy Absorption in Plastic Hinge of Beam-Column Connection

In earthquake-resistant design of buildings, plastic hinge zones in the beam adjacent to a beam-column joint serve as mechanical fuses that dissipate energy inelastically to protect the structural system under overload conditions. In general, it may be expected that the following properties of the concrete material in the plastic hinge should be advantageous: 1. high compression strain capacity to avoid loss of integrity by crushing; 2. low tensile first cracking strength to initiate damage within the plastic hinge; 3. high shear and spall resistance to avoid loss of integrity by diagonal fractures; and 4. enhanced mechanisms that increase inelastic energy dissipation. Conventionally, plastic hinge design uses a dense

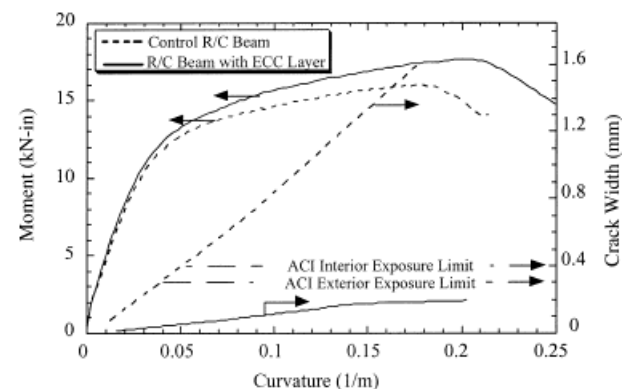

Figure 20 Moment and crack width-curvature diagrams.

amount of steel reinforcement, requiring significant labor in the construction process. In a recent study, Mishra and Li (1997) investigated the use of ECC to achieve these objectives instead of increased shear steel reinforcement.

The test specimen (Fig. 21) represents two half beams connected to a stub column, in a strong column–weak beam configuration. The beams are simply supported at their ends to represent mid-span inflection points, under lateral loading of a framed structure. Two specimens were tested, one using plain concrete (PC) for the entire specimen and the other using ECC material in the plastic hinge zone and PC in the rest of the specimen.

The load-versus-deflection hysteretic behavior is shown in Figure 22. For the PC hinge, the displacement ductility factor (defined as the ratio of ultimate deflection (corresponding to a failure load that is 20% lower than the maximum load-carrying capacity) to yield deflection) is about 4.8. For the ECC hinge, the displacement ductility factor increases to 6.4, with less amount of pinching and a much reduced rate of stiffness degradation (Mishra and Li, 1997). The cracking pattern was distinctly different with more cracking taking place in the plastic hinge zone with ECC rather than the zone outside as in the case of the PC control specimen. The damage is mostly in the form of diagonal multiple cracking in a perpendicular direction. Unlike the control specimen, which fails in a predominantly shear diagonal fracture, the ECC specimen fails by a vertical flexural crack at the interface between ECC plastic hinge zone and the plain concrete at the column face. No spalling was observed in the ECC

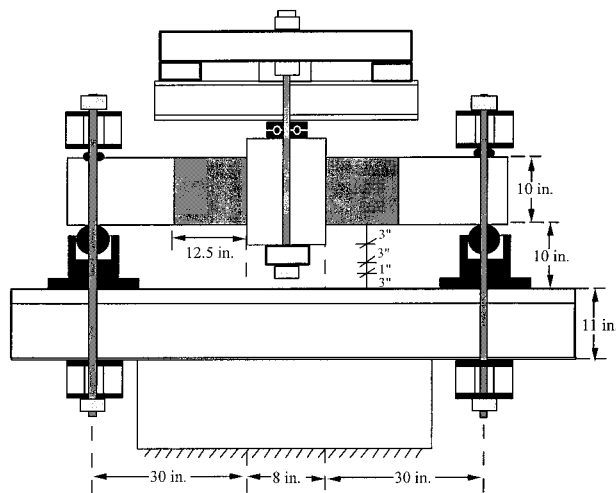

Figure 21 Schematics of experimental setup.

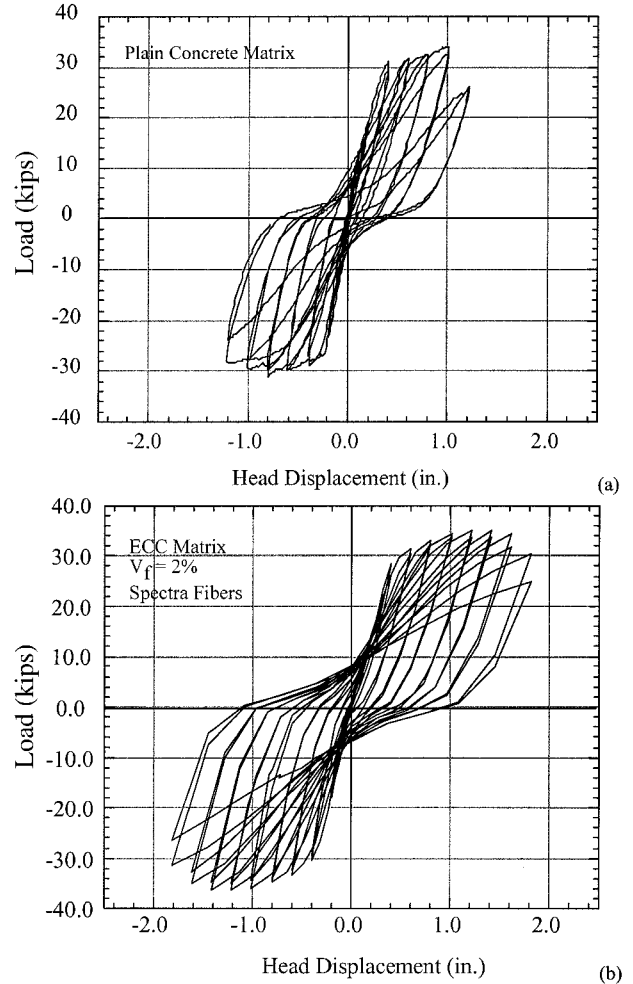

Figure 22 Load-versus-deflection response of specimen with (a) R/C plastic hinge; and (b) R/ECC plastic hinge.

hinge, whereas the concrete cover mostly disintegrated in the control. The cumulative energy over the load cycles for the two specimens are compared in Figure 23, which shows that the ECC hinge absorbs about 2.8 times as much energy as the control. The control specimen does behave in a manner similar to the ECC hinge specimen in its range of deflection. However, the ECC specimen far out-performs the control specimen in the deflection regime beyond 1.2". This investigation demonstrates that ECC can be utilized as effective energy absorption devices in structural systems that may be subjected to extreme overloads.

Shear Performance of Reinforced ECC Structural Members

To investigate the structural strength and ductility of reinforced beams under cyclic loads, PVA-

ECC (with $V_f = 2\%$) beams with conventional steel reinforcements (R/ECC) have recently been tested with four-point off-set loading, with the mid-span subjected to fully reversed uniform shear load (Kanda et al, 1998). Varied parameters in the tests include the span/depth ratio and amount of shear reinforcement. Control specimens with ordinary concrete (R/C) of similar compressive strength (30 MPa) as the ECC were also tested. All specimens have been designed with enough longitudinal reinforcement so that flexural failure is suppressed and beam failure is forced into the shear mode.

Figure 24 shows the double set of diagonal crack patterns in the shear span of the failed specimens. The R/ECC specimens reveal a much higher crack density, about four times that of the R/C specimens. Almost all cracks have opening less than 0.1 mm in the R/ECC compared with millimeter-sized cracks in the R/C specimens.

The load-deformation envelope curves for the test specimens are summarized in Figure 25. It is concluded that by replacing plain concrete with ECC in the shear beam: 1. load capacity increased by 50% and ultimate deformation by 200% under shear tension failure mode (comparing ECC-1-0 with RC-1-0), and 2. load capacity increased by 50% and ultimate deformation remains the same under shear compression failure mode (comparing ECC-1-1 with RC-1-1). These observations and Figure 24 suggest that R/ECC outperforms R/C in shear performance (load capacity, ductility, and crack control). R/ECC beams behave in a ductile manner even without transverse reinforcement (but is further enhanced by combining ECC with transverse reinforcement), and remain

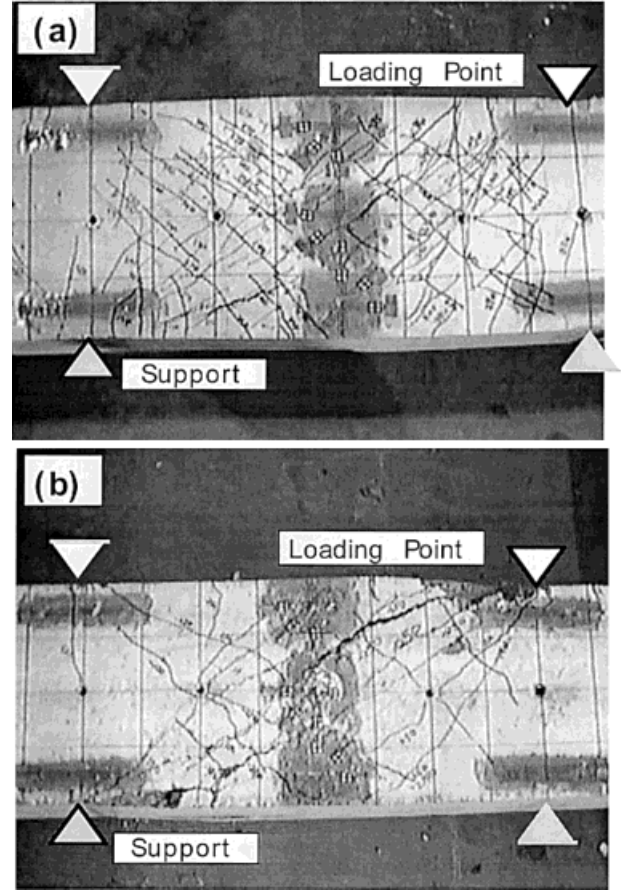

Figure 24 Crack patterns of shear specimens (a) R/ECC, and (b) R/C.

ductile even for short span shear elements which are known to fail in a brittle manner with normal concrete. This investigation establishes confi-

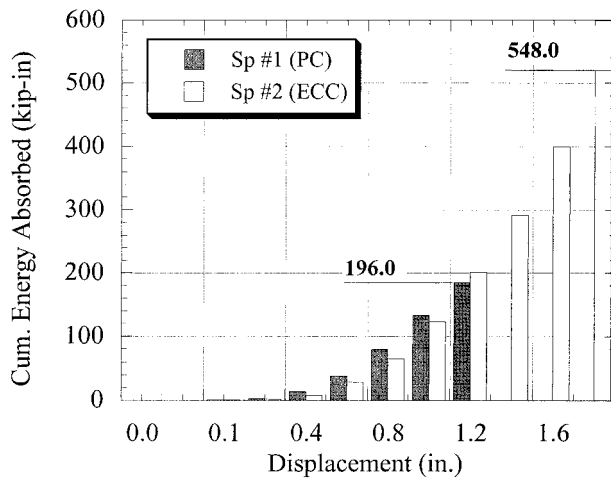

Figure 23 Comparison of cumulative energy absorption versus deflection of ECC hinge versus the control.

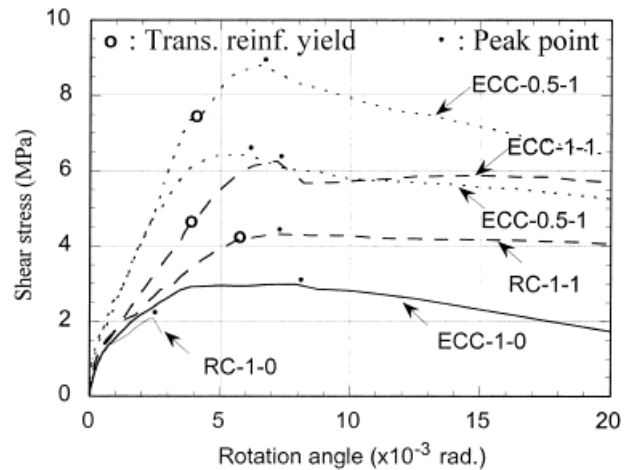

Figure 25 Shear stress-rotation envelope curves for the various specimens. Each curve is labeled (material-span/depth ratio-shear reinforcement %).

dence in the application of ECCs in structural shear elements.

Conditions for Pseudo-Strain-Hardening

The studies summarized in this section demonstrate that the high-performance ECC can be utilized in structural applications to enhance structural performance. Because the ECC uses 2 or less vol % of synthetic fibers in chopped form, there is no processing difficulty. The specimens have been manufactured by regular casting method and using ordinary laboratory mixers. Further tailoring of the ECC, with the aid of the micromechanical models, is possible to reduce the amount of fibers and hence the cost.

The conditions for making the cementitious composite undergo transition from ordinary FRC tension-softening behavior to a pseudo-strain-hardening behavior have been intensively studied in recent years (Li and Leung, 1992; Li, 1998). The results can be summarized as a requirement for fiber content exceeding a minimum V_f^{crit} defined in terms of fiber, matrix, and interface properties:

$$V_f^{\text{crit}} \equiv \frac{12J_c}{g\tau(L_f/d_f)\delta_o} \quad (8)$$

Equation (8) suggests that strain-hardening can be achieved with lower fiber content when the matrix toughness J_c is low, interface frictional bond strength τ is high (but fiber does not break), and if fiber aspect ratio L_f/d_f is high. The term δ_o in eq. (8) contains additional dependent fiber, matrix, and interface parameters detailed in Li (1992). Equation (8) is valid for the case when fibers are pulled out instead of rupture. The extension of eq. (8) to composites using fibers that rupture have been investigated recently (Kanda and Li, 1998).

FAVORABLE FIBER CHARACTERISTICS

Based on the discussions above, some ideal fiber characteristics can be summarized: diameter = 30–50 μm ; elastic tensile modulus > 30 GPa; tensile strength > 1000 MPa; tensile strain capacity > 3.0%; density < 2 g/cc; length: customizable; target fiber content < 2% by volume; chemical stability: corrosion resistant, chemically stable in cement environment; interface frictional bond strength with cement = 3–6 MPa depending

on fiber strength, stable over time, little or no chemical bonding.

The small ideal fiber diameter useful for achieving high aspect ratio puts most metallic fibers at a disadvantage. The recommended diameter range is, however, easily achievable by polymer fibers. An upper limit, probably around 250, may be imposed to prevent overly large aspect ratio as to render the mixing process difficult. This number is dependent on the mixer type and rheological control of the fresh mix by chemical additives.

Unlike fiber reinforced plastics (FRP), the elastic modulus of fibers in FRC does not play as important a role because the composite modulus of FRC comes mainly from the concrete matrix itself and not from the fiber. This is so because practical fiber volume fraction in FRC is several percent in contrast to $\sim 50\%$ in FRP, in addition to its being randomly oriented. Instead, fibers in FRC are used to improve toughness and ductility, implying that their usefulness comes into effect after matrix cracking begins. For FRP, fiber stiffness provides the elastic stiffness of the composite before any fiber or matrix damage. However, it should be recognized that the width of cracks in concrete are important for governing ingress of aggressive agents and therefore the structural durability. Crack width in pseudo-strain-hardening materials are even more important because the material may be expected to operate in the multiple cracking range during which many microcracks can form. The crack width of the FRC will be governed by the elastic modulus of the bridging fibers, among other factors. For the recommended minimum fiber modulus, metal (both steel or Metglas) and some carbon fibers should meet this requirement quite easily. Most of the polymer fibers currently in use for FRC reinforcement would fall short of the 30 GPa. However, an increasing number of moderate- to high-performance polymer fibers with a modulus higher than 30 GPa are coming into the market. Those already in commercial production include Kevlar[®], high modulus polyethylene (Spectra, Centran, Dyneema), and PVA.

Fiber tensile strength governs fiber rupture and therefore the maximum bridging load the fiber can carry across an opening matrix crack. All the desirable composite properties discussed above will diminish with decreasing fiber strength. In general, the fiber tensile strength and modulus go together. The recommended fiber strength again can be met by most metal and some carbon fibers, as well as by the group of

higher-performance polymer fibers mentioned above.

The tensile strain capacity is important in preventing fiber failure especially during the mixing process. Fiber breakage during mixing reduces fiber length and therefore fiber aspect ratio and reinforcement efficiency in the composite. In addition, the tensile strain capacity is critical for fibers to survive as the matrix crack opens. This is so because the randomly oriented fibers need to bend and sometimes severely in this bridging process. Most current carbon fibers with low tensile strain capacity suffer from this deterioration effect. In contrast, metal fibers, and particularly polymer fibers, do very well in this category.

Fiber density is not critical in terms of mechanical or even physical properties of the composite because they are not used in high fiber volume fraction. However, they are important in determining the economic feasibility of the fiber used in concrete reinforcement. This is because, in general, fibers are priced on a unit weight basis, but their reinforcement effectiveness responds to fiber content in volume rather than weight. Hence, for the same fiber volume fraction dosage, a high-density fiber will weigh and cost more than a corresponding fiber with low density. For example, the density for steel is about 7.8 g/cc whereas that of polymer fibers can be slightly below 1 g/cc. A translation factor (of ~ 7.8) should be used whenever costs of fibers (steel versus polymer) are compared. Carbon fibers should also do well because their density typically is in the range of 1.5–2.5 g/cc.

Chemical stability is important for composite durability and sometimes aesthetics (depending on the structure or product). In terms of corrosion resistance, both carbon and polymer fibers do extremely well in comparison with steel. However, metal fibers can be made corrosion resistant (e.g., stainless steel and Metglas fibers). In terms of chemical stability, carbon fibers are most inert. Some polymer (and glass) fibers are known to suffer degradation over time in the alkaline environment of the cementitious matrix material.

Composite action is derived from having an appropriate interface bond. If the bond is too low, fibers slip out too easily and no bridging action can be achieved. This leads to poor toughness, ductility, and other important composite properties. If the bond is too high, fibers will break in the matrix instead of frictionally slide out. In the extreme case, the material will appear like a monolithic material with no fibers. Again, all desirable composite properties are lost. The desir-

Table V Ranking of Characteristics for Metal, Carbon, and Polymer Fibers in General

Fiber Characteristics	Metal	Carbon	Polymer
Diameter	–	+	++
Modulus	+	+	–
Tensile strength	+	+	–
Tensile strain	+	–	++
Density	–	+	++
Chemical stability	–	++	+
Interface bond	++	+	–
Cost	+	–	+

able range should be scaled with the length, diameter, and strength of the fibers used. The recommended range also takes into account that fiber length cannot be too long because of difficulty in processing. Bond strength for steel fibers are generally in the 4-MPa range and could be higher because of mechanical interlock associated with deformed shape of the fiber or because of a dense surrounding matrix. Bond strength of carbon fibers tends to be highly variable. Reported strength ranges from 2 to 8 MPa. The variability is likely attributable to the difficulty in conducting the fiber pull-out test because of the brittle nature and small diameter of carbon fibers. Polymer fibers tend to do poorly in this category, with bond strength typically below 1 MPa. An exception is hydrophilic PVA fiber which appears to have a chemical bonding with interface toughness in the several J/m² range and a frictional bond of 2–5 MPa. Such high bond can lead to excessive fiber rupture and loss of composite ductility if not properly tailored with other fiber and matrix parameters.

The durability of interfacial bond is not well understood. There has been a reported increase in bond over age for some fibers, including certain glass, polymer, and carbon fibers. The most stable interface bond appears to be held in metal fibers.

The fiber characteristics discussed herein are summarized in Table V for the three broad groups of metal, carbon, and polymer fibers. The + and – signs are used to represent advantage or disadvantage in the characteristics of each fiber type currently in use for concrete reinforcement. However, carbon, and especially polymer, fibers are undergoing rapid technological advancements, much more so than metal fibers. Thus, some of the negatives in the current generation of these materials are likely to be corrected. For example, polymer fiber modulus and carbon fiber tensile

strain can be expected to continuously improve. For some specific fibers, these improvements are already here today. For carbon fibers, special processing routes are allowing lower-cost fibers with good properties to be manufactured.

Steel fiber has many excellent properties for structural applications of FRC. Future advances in steel fibers appear to be in the direction of optimization of the fiber geometric shape. Fundamental changes in mechanical properties are not expected. In contrast, fundamental improvements in properties for both carbon, and especially polymer, fibers are already occurring. For carbon fibers, current commercially available carbon fibers are either extremely high performance (such as that made by Amoco), or rather poor-performing pitch-based fibers. Modern processing technology is emerging to make excellent performing pitch-based fibers with properties matching currently available polyacrylonitrile-based carbon fibers. In the polymer group, the technical performance is already existing in some high-performance polymeric fibers but the cost is rather high. In most cases, these materials are not developed for concrete reinforcement.

It would be extremely advantageous to the construction industry if fibers would be specifically developed by fiber manufacturers and tailored for cementitious matrix reinforcement. To make this happen, both FRC end-users and fiber manufacturers need to better appreciate the fiber properties needed for optimal reinforcements in such matrices. For a given fiber type, it is generally possible to manufacture fibers with a range of mechanical and geometric properties. Tailoring implies the selection of a particular profile of such properties—fiber length and diameter, elastic modulus, tensile strength, elongation, and surface treatment, recognizing that some of these parameters are dependent on each other. The optimal combination can be obtained from model guidance as explained previously in this article.

CONCLUSIONS

1. A wide range of current concrete elements and products take advantage of a variety of properties offered by FRCs. Although some aspects of mechanical-performance improvements are achieved, most of these current applications involve concrete elements that are not designed as load-carrying structural members. Nevertheless, new

applications of FRCs are continuously uncovered worldwide.

2. Laboratory research has demonstrated that fibers can lead to enhancements in structural performance. Structural members loaded in bending, shear, torsion, and compression show improvements in structural capacity and ductility. However, the laboratory investigations are usually limited to steel fibers and field demonstrations are lacking.
3. The degree to which fibers are effective in structural enhancements depends not only on the FRC properties themselves, but also on the amount of conventional steel reinforcement present. Fibers are particularly effective in applications in which conventional steel reinforcement is difficult or undesirable. Fibers can be used structurally to replace steel, such as stirrups, or to reduce steel congestion in structural elements designed to withstand seismic loads. However, in some structural elements, the synergistic interaction between fibers and conventional reinforcement and strategic location of FRC in the member can lead to significant enhancements in structural performance.
4. The design of concrete structures using FRC, having just begun, remains largely to be explored. The design process must take into account the proper load-carrying capability of fibers. This will also allow characterization of fiber, interface, and concrete properties optimal for structural performance.
5. Structural members, whether cast-in-place or precast, are emerging as the next target for fiber application. Structural performance demand, demonstrated effectiveness of fiber reinforcement, and continuously improved FRC properties, combined to guide industry leaders to adopt FRC as a structural material. Global competition among construction companies, among precast products producers (which may take the form of competition between concrete-versus-steel or plastics products), and demand for more durable and safe infrastructures, will continue to exert pressure for new concrete with properties not available without fiber reinforcements. Advanced FRCs will be needed for both new and repaired infrastructures.

6. Current high-performance FRCs targeted at structural applications tend to involve a high-volume fraction of steel fibers. The potential of other fiber types such as synthetic fibers and carbon fibers are underexplored.
 7. Pseudo-strain-hardening cementitious composites with high tensile ductility could eventually become economically competitive for use in structural members. With the drastically different (but improved) mechanical properties, structural design procedures will also need to be modified to take proper advantage of this material.
 8. The building and construction industry has very high sensitivity to material cost. Introduction of fibers into concrete must therefore bring about significant improvements in structural performance. Systematic material optimization—using the minimum amount of expensive material for maximum structural enhancement, rather than empirical trial-and-error approach, should provide the most direct path to satisfying the required benefit/cost ratio in this industry.
 9. The successful introduction of carbon and PVA fibers into concrete elements in Japan appears to have benefited from a strategic alliance between fiber producers and constructed facilities providers. This creates a healthy feedback loop on end-user needs and fiber characteristics engineering. Strategic alliance should be particularly helpful in new market penetrations.
 10. With improved understanding of the link between fiber characteristics and composite/structural performance based on micro-mechanics, the opportunity for tailoring of fibers for use in the high-volume construction market exists, particularly for load-carrying structural systems.
3. Aveston, J.; Cooper, G. A.; Kelly, A. in the Properties of Fiber Composites; Conference Proceedings, IPC Science and Technology Press: Guildford, UK, 1971; pp 15–24.
 4. Bache, H. H. Compact Reinforced Composite Basic Principles; CBL Report No. 41, Aalborg Portland: Denmark, 1987.
 5. Bache, H. H. in Fracture Mechanics of Concrete Structures: From Theory to Applications; Elfgren, L., Ed.; Chapman & Hall: London/New York, 1989; pp 382–398.
 6. Balaguru, P.; Gambrova, P. G.; Rosati, G.; Schuman, C. E. in HPFRCC-95 Workshop Preproceedings; Naaman, A. E.; Reinhardt, H. W., Eds.; 1995; pp 325–334.
 7. Balaguru, P.; Shah, S. Fiber Reinforced Cement Composites; McGraw Hill: New York, 1992.
 8. Batson, G. Steel Fiber Concrete; Shah, S. P.; Skarendahl, A., Eds.; Elsevier: New York, 1985; pp 377–419.
 9. Bentur, A. in Fiber Reinforced Concrete: Modern Development; Banthia, N.; Mindess, S., Eds.; Univ. of British Columbia: Vancouver, 1995, pp 187–199.
 10. Brandt, A. Research in Advanced Cementitious Composites; Polish Academy of Sciences, Institute of Fundamental Technological Research, Dec., 1994.
 11. Brandt, A. M.; Glinicki, M. A.; Potrzebowski, J. in Proceedings of the Workshop on Fiber Reinforced Cement and Concrete; Sheffield, Jul. 1994, pp 400–414.
 12. CFRC Brochure; Kajima Corporation.
 13. Craig, R. Flexural Behavior and Design of Reinforced Fiber Concrete Members; ACI-SP105, 1987; pp 517–564.
 14. Craig, J. R.; Dymna, S.; Riaz, J.; Shirazi, H. in Fiber Reinforced Concrete; International Symposium SP-81, ACI, Detroit, MI, 1984; pp 17–49.
 15. Densit, Brochure about Densitop, Densit A/S, Aalborg Portland.
 16. Engineer Update; Oct., 1984, Vol. 8, No. 10, 3 pp.
 17. Ezeldin, A.; Balaguru, P. ACI Mater J 1989, 86, 515–524.
 18. Glavind, M., Ed. Fiber Concrete. State of the Art Report. Framework Program Cement-Based Composite Materials under the Material Technological Program 1989–92 [in Danish]. Concrete Centre, Danish Technological Institute, Nov. 1993.
 19. Gregersen, J. C. Construction of Auxiliary Equipment for Casting of Fiber Concrete, Report in task Group 7 [in Danish], The Institute of Product Development, Technical University of Denmark, Nov. 1992.
 20. Hillerborg, A.; Modeer, M.; Petersson, P. E. Cement Concrete Res 1976, 773–782.
 21. Horii, H.; Nanakorn, P. in Proceedings of the JCI International Workshop on Size Effect in Concrete Structures; Sendai, Japan, 1993; pp 347–358.
 22. Horii, H.; Matsuoka, S.; Kabele, P.; Takeuchi, S.; Li, V. C.; Kanda, T. Fracture Mechanics of Concrete Structures, Proceedings FRAMCOS-3; AEDI-

Industrial sponsors include W. R. Grace, Rocla Technology (Australia), E. I. DuPont, Conoco Inc., Eternit Corp. (Switzerland), Kuraray Corp. (Japan), and Redco Corp. (Belgium).

REFERENCES

1. Ando, T. et al. in Thin-Section FRC and Ferroce-ment; ACI SP 124-3, 1990; pp 39–60.
2. Akihama, S.; Kobayashi, M.; Suenaga, T. Mechanical Properties of Carbon Fiber Reinforced Cement Composite and the Applications to Buildings (Part 2); Report No. 65, Kajima Institute of Construction Technology: Tokyo, Japan, 1986.

- FICATIO Publishers: Freiburg, Germany, Oct. 1998, pp 1739–1750, to appear.
23. Johnston, C. D. in *Fiber Reinforced Concrete: Modern Development*; Banthia, Mindess, Eds.; pp 87–100.
 24. Kanda, T.; Watanabe, S.; Li, V. C. *Fracture Mechanics of Concrete Structures*, Proceedings FRAMCOS-3, AEDIFICATIO Publishers: Freiburg, Germany, Oct. 1998, pp 1477–1490, to appear.
 25. Kanda, T.; Li, V. C.; Hamada, T. *Material Design and Development of High-Ductility Composite Reinforced with Short Random Polyvinyl Alcohol Fiber*; 1998, 20(2), 229–234.
 26. KaTRI Brochure on Exhibits and Laboratory.
 27. Kaushik, S. K.; Sasturkar, P. J. *Fiber Reinforced Cements and Concrete: Recent Developments*; Elsevier: New York, 1989; pp 687–698.
 28. Lankard, D. R. in *HPFRCC-1*; Reinhardt, H. W.; Naaman, A., Eds.; E & FN Spon, 1992; pp 195–202.
 29. Li, V. C. *ASCE J Mater Civil Eng* 1992, 4(1), 41–57.
 30. Li, V. C. in *Fiber Reinforced Concrete: Present and the Future*; Banthia, N.; Bentur, A.; Mufti, A., Eds.; Canadian Society for Civil Engineering: Montreal, 1998; pp 64–97.
 31. Li, V. C.; Leung, C. K. Y. *ASCE J Eng Mech* 1992, 118(11), 2246–2264.
 32. Li, V. C.; Chan, C. M.; Leung, C. K. Y. *J Cement Concrete Res* 1987, 17(3), 441–452.
 33. Li, V. C.; Stang, H. J *Adv Cement Based Mater* 1997, 6(1), 1–20.
 34. Li, V. C.; Stang, H.; Krenchel, H. J *Mater Struct* 1993, 26, 486–494.
 35. Li, V. C.; Wang, Y.; Backer, S. J *Mech Phys Solids* 1991, 39(5), 607–625.
 36. Maage, M. in *Proceedings of the International Symposium on Brittle Matrix Composites 4*; Brandt, A. M.; Li, V. C.; Marshall, I. H., Eds.; Sept. 1994, IKE and Woodhead Publishers: Warsaw, 1994; pp 27–34.
 37. Maalej, M.; Li, V. C. *Am Concrete Inst Struct J* 1995, 92(2), 167–176.
 38. Maalej, M.; Li, V. C.; Hashida, T. *ASCE J Eng Mech* 1995, 121(8), 903–913.
 39. Mishra, D. Ph.D. Thesis, University of Michigan, Ann Arbor, MI, 1995.
 40. Mufti, A. A.; Jaeger, L. G.; Bakht, B.; Wegner, L. D. *Can J Civil Eng* 1993, 20, 398–406.
 41. Naaman, A. *Fiber Reinforcement for Concrete*; Concrete International, March, 1985; pp 21–25.
 42. Naaman, A. E. in *Proceedings of the International Workshop on High Performance Fiber Reinforced Composites*; Reinhardt, H. W.; Naaman, A., Eds.; Mainz, 1991; pp 18–38.
 43. Packard, R. G.; Ray, G. K. *FRC International Symposium*, ACI SP-81 1984, 325–348.
 44. Pederson, E. J. *Fiber Concrete for Pipes* [in Danish]; Unicon Beton, Dec. 1992.
 45. Ramakrishnan, V. *Performance Characteristics of 3M Polyolefin Fibre Reinforced Concrete*; Report submitted to the 3M Company, St. Paul, MN, Dec. 1993.
 46. Ramakrishnan, V. *Evaluation of Non-Metallic Fibre Reinforced Concrete in PCC Pavements and Structure*; Study SD 94-04, Interim Report submitted to the South Dakota DOT, Pierre, SD, Dec. 1994.
 47. Rambøll Hannemann & Højlund A/S m. fl. *Fiber Concrete for Structural Elements and on-site Structures* [in Danish]; Rambøll Hannemann & Højlund A/S; Denmark, 1992.
 48. Rambøll Hannemann & Højlund A/S m. fl. *Cement-Based Composite Materials: Concrete Repair with Fiber Materials* [in Danish]; main report and annex, Rambøll Hannemann & Højlund A/S: Denmark, 1992.
 49. Richard, P.; Cheyrezy, M. H. *ACI Spring Convention*, San Francisco, CA, 1994.
 50. Sakai, K.; Ochi, T.; Kitoh, M. in *Proceedings of the 2nd University-Industry Workshop on FRC & Other Advanced Composites*, Toronto, Canada; Banthia, N.; Mindess, S., Eds.; 1995; pp 51–62.
 51. Shirai, A.; Ohama, Y. in *Fiber Reinforced Concrete: Modern Development*; Banthia, Mindess, Eds.; pp 201–212.
 52. Smith, R. E. in *Fiber Reinforced Concrete: Modern Development*; Banthia, Mindess, Eds.; pp 117–127.
 53. Stang, H. *BMC Conference Applications of FRC in Denmark*, 1994.
 54. Stang, H.; Aarre, T. *Cement Concrete Compos* 1992, 14(2), 143.
 55. Stang, H.; Li, V. C.; Krenchel, H. J *Mater Struct* 1995, 28, 210–219.
 56. Thygesen, E. Ph.D. Thesis, Technical University of Denmark, 1993.
 57. Tsukamoto, M. *Darmstadt Concrete Ann J Concrete Concrete Struct* 1990, 5, 215–225.
 58. Rossi, P.; Harrouche, N. *Mater Struct* 1990, 23, 256.
 59. Van Mier, J. G. M.; Stang, H.; Ramakrishnan, V. in *High Performance Fiber Reinforced Cementitious Composites*; HPFRCC-95; Naaman, A. E.; Reinhardt, H. W., Eds.; 1995; pp 387–399.
 60. Visalvanich, K.; Naaman, A. E. *Progress Report for NSF Grant ENG 77-23534*, University of Illinois at Chicago Circle, 1982.
 61. Wang, Y.; Li, V. C.; Backer, S. *Am Concrete Inst Mater J* 1990, 87(5), 461–468.
 62. Yurugi, M.; Nobuta, Y.; Yama, T.; Kimura, H. in *Kajima Technical Research Institute Annual Report* [in Japanese]; 1991, 39, 27–37.